



implantologia dental
implantologie dentaire

Dental Implantology
Zahnärztliche Implantologie

Zahnärztliche Chirurgie
Dental surgery
Chirurgia dentale
Cirugia dental
Chirurgie dentaire



Implantologia dental
Implantologie dentaire

Dental Implantology

Zahnärztliche Implantologie

Zahnärztliche Chirurgie
Dental surgery
Chirurgia dentale
Cirugia dental
Chirurgie dentaire



Zahnärztliche Chirurgie
Dental surgery
Chirurgia dentale
Cirugia dental
Chirurgie dentaire

Gauges	40	39	38	37	36	35	34	33	32	31	30	29	28	27	26	25	24	23	22	21	20	19	18	17	16	15	14	13	12	11	10													
mm	0.12	0.13	0.15	0.17	0.19	0.21	0.22	0.25	0.27	0.28	0.30	0.33	0.35	0.40	0.46	0.50	0.56	0.61	0.71	0.81	0.91	1.01	1.22	1.42	1.62	1.83	2.03	2.34	2.64	2.94	3.25													
Charriere N.	1	2	3	4	5	6	7	8	9	10	11	12	13	14	15	16	17	18	19	20	21	22	23	24	25	26	27	28	29	30	31	32	33	34	35	36	37	38	39	40				
mm	Ø 1/8	Ø 3/16	Ø 1/4	Ø 5/16	Ø 3/8	Ø 7/16	Ø 1/2	Ø 9/16	Ø 5/8	Ø 11/16	Ø 3/4	Ø 13/16	Ø 7/8	Ø 15/16	Ø 1 1/16	Ø 1 1/8	Ø 1 1/4	Ø 1 3/8	Ø 1 1/2	Ø 1 5/8	Ø 1 3/4	Ø 1 7/8	Ø 2	Ø 2 1/8	Ø 2 1/4	Ø 2 3/8	Ø 2 1/2	Ø 2 5/8	Ø 3	Ø 3 1/8	Ø 3 1/4	Ø 3 3/8	Ø 3 1/2	Ø 3 5/8	Ø 4	Ø 4 1/8	Ø 4 1/4	Ø 4 3/8	Ø 4 1/2	Ø 4 5/8	Ø 5			
mm	10	20	30	40	50	60	70	80	90	100	110	120	130	140	150	160	170	180	190	200	210	220	230	240	250	260	270	280																
Inches	1	2	3	4	5	6	7	8	9	10	11	12	13	14	15	16	17	18	19	20	21	22	23	24	25	26	27	28	29	30	31	32	33	34	35	36	37	38	39	40				

Instrumente aus martensitischem Stahl

Alle Bontempi Instrumente werden mit dem besten martensitischen Stahl, auch „chirurgischer Stahl“ genannt, hergestellt. Sollten aber die Instrumente der Wirkung von bestimmten Chemikalien ausgesetzt werden oder sollten die empfohlenen Konzentrationen/Einlegezeiten nicht beachtet werden, kann es zu Glanzverlust, Korrosion oder sogar zu einer Veränderung der oberflächlichen physischen Eigenschaften kommen.

Deshalb dürfen Instrumente aus chirurgischem Stahl nie längere Zeit der Wirkung von Chloridlösungen ausgesetzt werden. Außerdem dürfen solche Instrumente nie der Wirkung von Chlorlösungen, Hypochloriten, Eisenchlorid, Salzsäure und Jod ausgesetzt werden, oder längere Zeit in Kontakt mit den o.g. chemischen Mitteln bleiben.

Martensitic steel instruments

All Bontempi instruments are made up of high quality martensitic steel, also known as surgical steel. Nevertheless, in case of exposure to the action of some particular chemical substances, or should these substances be used in wrong doses or exposures not be observed, instruments might be subject to loss of polish, corrosion or even to an alteration of their superficial physical properties.

Therefore, surgical steel instruments shouldn't be exposed to the prolonged action of chloride solutions. Moreover, instruments should never be exposed to the action of or kept in prolonged contact with chlorine solutions, hypochlorites, ferric chloride, hydrochloric acid and iodine.

Strumenti in acciaio martensitico

Tutti gli strumenti Bontempi sono prodotti con i migliori acciai martensitici, detti anche acciai chirurgici, tuttavia se sottoposti all'azione di alcune particolari sostanze chimiche o in dosi o tempi superiori a quelli raccomandati, possono essere soggetti a perdita di lucentezza, corrosione o addirittura possono essere alterate le loro qualità fisiche superficiali.

E' quindi indispensabile non sottoporre gli strumenti in acciaio chirurgico all'azione prolungata di soluzioni di cloruri. Gli strumenti, inoltre, non devono mai essere sottoposti all'azione o al contatto prolungato con soluzioni di cloro, ipocloriti, cloruro ferrico, acido cloridrico, iodio.

Instrumental en acero martensítico

Todos los instrumentos Bontempi están fabricados con el mejor acero martensítico acero quirúrgico de máxima calidad, pero aún así puede sufrir corrosión o pérdida de brillo si ha soportado la acción de alguna sustancia química en dosis o tiempo superior al recomendado por el fabricante.

Por este motivo el instrumental quirúrgico NUNCA debe ser expuesto a la acción del cloro, hipoclorito, cloruro férrico, ácido clorhídrico o yodo, por un período superior al recomendado ni en un porcentaje que no sea el adecuado y recomendado por el fabricante.

Instruments avec acier martencitique

Tous les instruments Bontempi sont fabriqués avec les meilleurs aciers martensitique, aussi appelés aciers chirurgicaux. Toutefois, s'ils sont soumis à l'action de certaines particules de substances chimiques en quantité supérieure à celle recommandée, ces instruments peuvent alors perdre leur clarté et leur qualité peuvent être altérée à cause de la corrosion.

Il est indispensable de ne pas soumettre ces instruments en acier chirurgical à des solutions de chlorure de façon prolongée. Il est en de même pour l'exposition au chrome à l'Hypochlorite, à la chlorure ferrique, à l'acide chlorhydrique et à l'iode.

Zahnärztliche Implantologie
Dental Implantology
Implantologia dentale
Implantologia dental
Implantologie dentaire

Zahnärztliche Chirurgie
Dental surgery
Chirurgia dentale
Cirugia dental
Chirurgie dentaire



Stumpf - Blunt
Smussa - Romas
Mousse

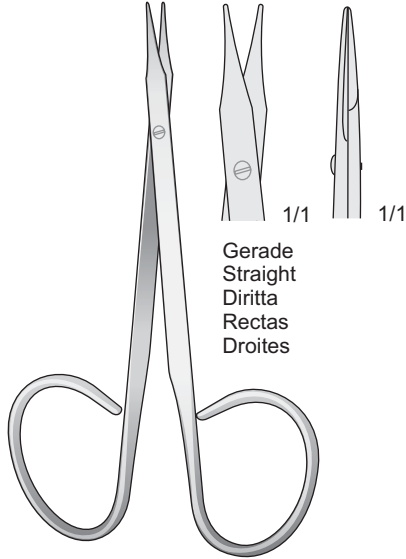

Gerade
Straight
Diritta
Rectas
Droites

STEVENS
FG-209
100 mm

Stumpf - Blunt
Smussa - Romas
Mousse

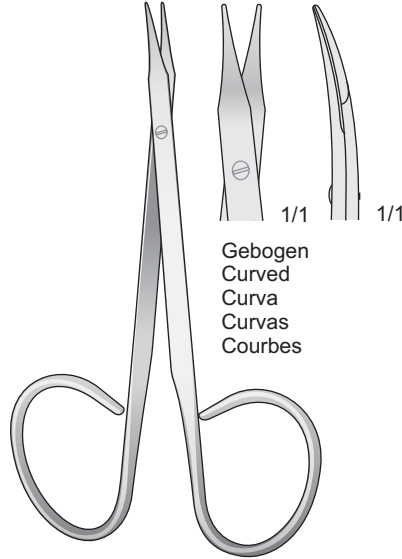

Gebogen
Curved
Curva
Curvas
Courbes

STEVENS
FG-210
100 mm

Gezahnt - Serrated
Dentellate - Dentelés
Dentadas

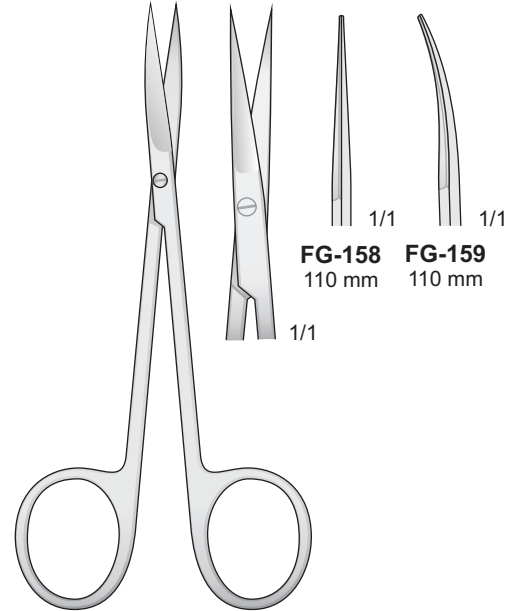

FG-158 FG-159
110 mm 110 mm

Spitz - Sharp
Acuta - Aguda
Pointu

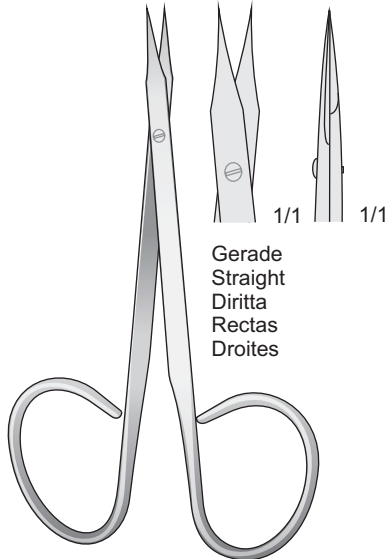

Gerade
Straight
Diritta
Rectas
Droites

WALTON
FG-211
100 mm

Spitz - Sharp
Acuta - Aguda
Pointu

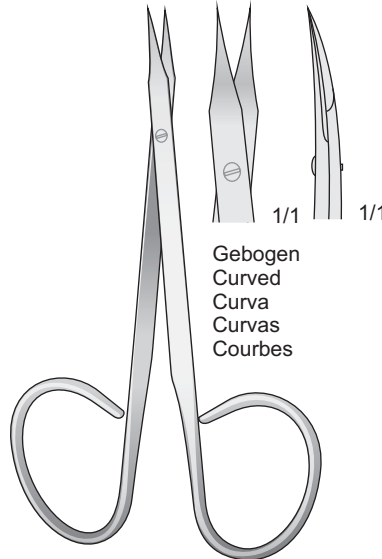

Gebogen
Curved
Curva
Curvas
Courbes

WALTON
FG-212
100 mm

Spitz - Sharp
Acuta - Aguda
Pointu

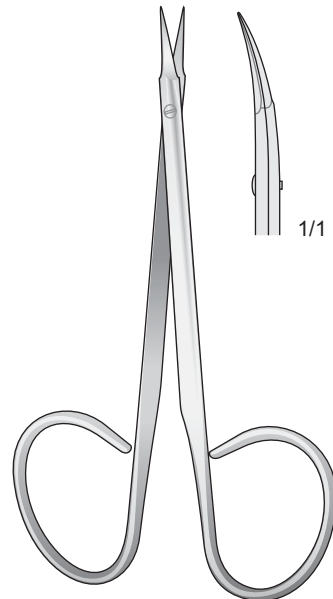

STITCH
FG-216
115 mm



Spitz - Sharp - Acuta - Agudo - Aigu

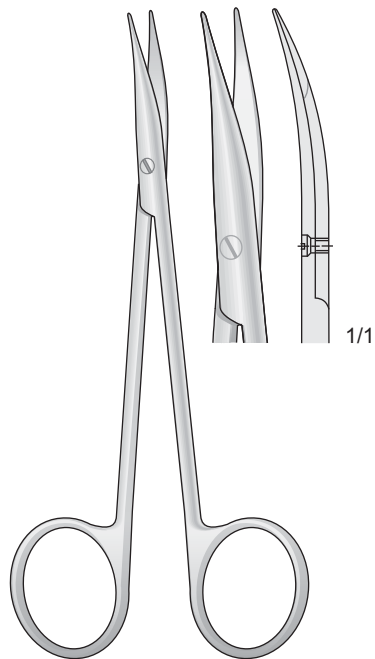

JAMESON-WERBER
FG-123
130 mm

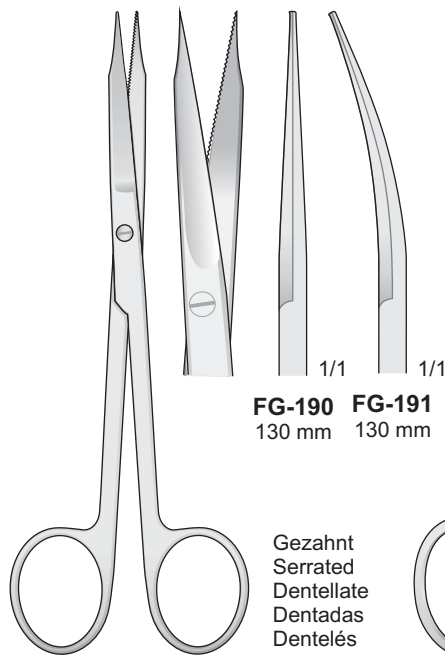

GOLDMAN-FOX
FG-190/FG-191
130 mm

FG-190 FG-191
130 mm 130 mm

Gezahnt
Serrated
Dentellate
Dentadas
Dentelés

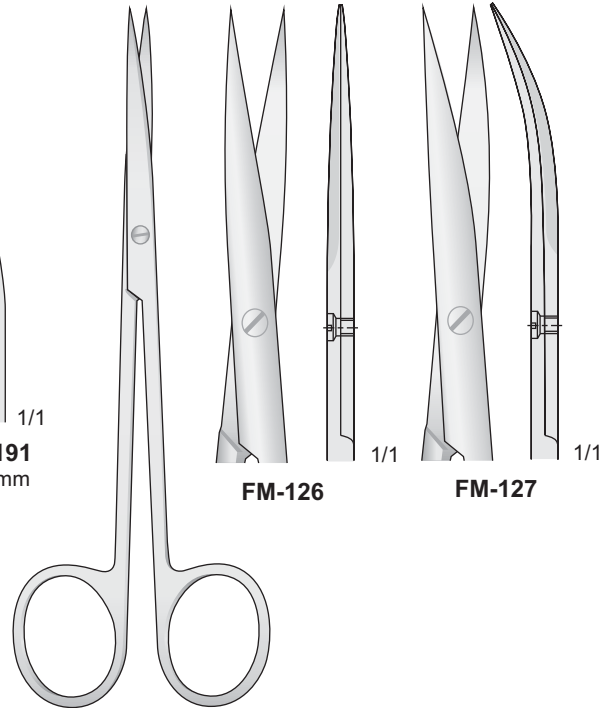

METZENBAUM
FM-126/FM-127
145 mm

FM-126

FM-127

Mit Hartmetalleinsätzen - Tungsten-carbide scissors
Con punta al carburo di tungsteno - Tijeras de tungsteno
Avec plaquettes en carbure de tungstène

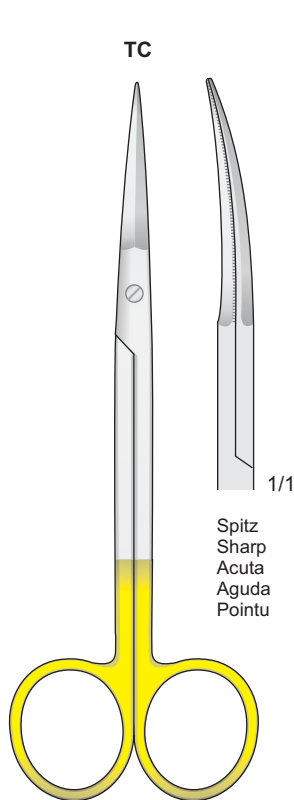

PECK-JOSEPH
FG-92
140 mm

Spitz
Sharp
Acuta
Aguda
Pointu

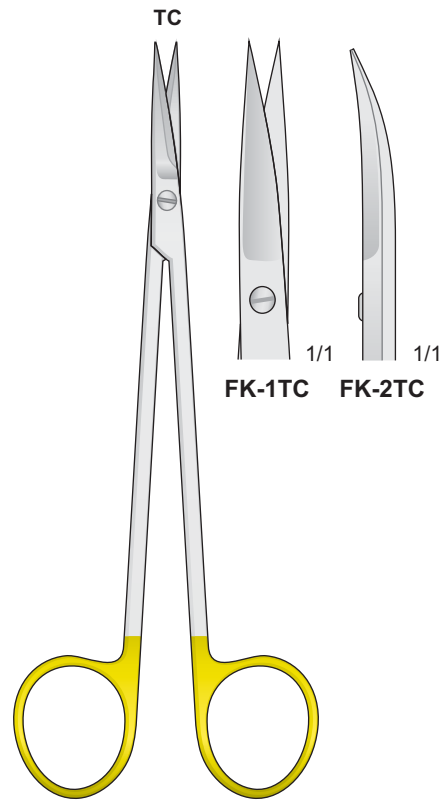

KELLY
FK-1TC/FK-2TC
160 mm

FK-1TC FK-2TC



“Super-cut” Scheren micro-schliff für tissue atrauma
 “Super-cut” scissors for gripping tissue and cutting interproximally
 Forbici “Super-cut” estremamente taglienti per tessuti con riduzione del trauma
 Tijeras “super cortes” para cortar tissue-atrauma
 Ciseaux “super cut” coupe les tissus en reduisant les risques de traumatisme

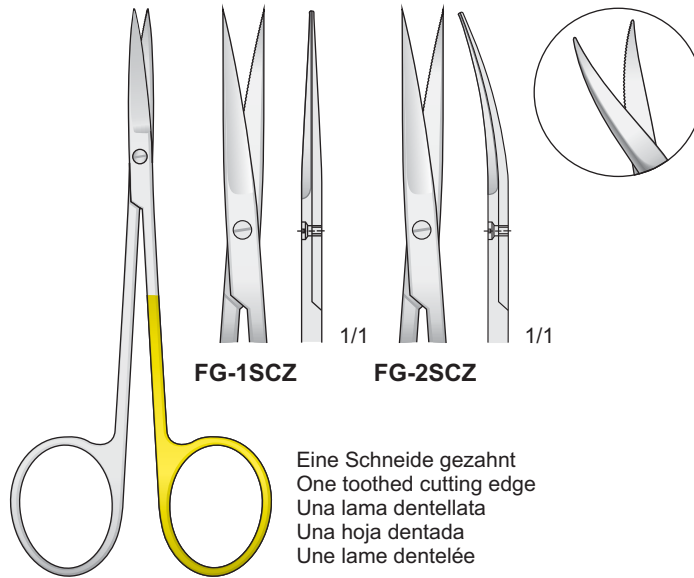

FG-1SCZ FG-2SCZ

Eine Schneide gezahnt
 One toothed cutting edge
 Una lama dentellata
 Una hoja dentada
 Une lame dentelée

FG-1SCZ/FG-2SCZ
110 mm

Scheren mit Wellenschliff auf einer Schnittfläche
 Scissors cut one serrated cutting edge
 Forbici con taglio ondulato su una lama - Tijeras con onda afilados
 Ciseaux avec affutage spécial ont une lame dentée

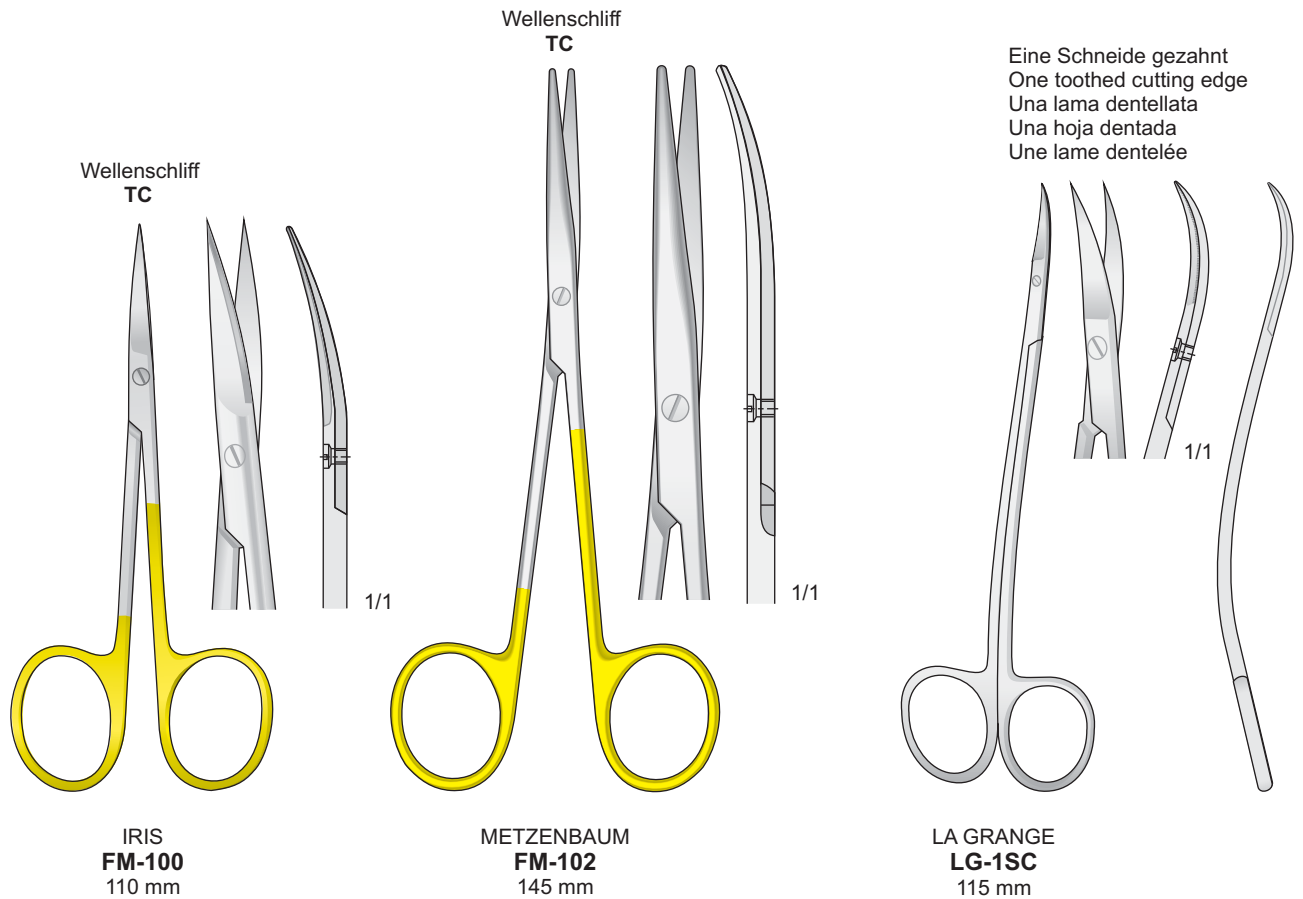

Eine Schneide gezahnt
 One toothed cutting edge
 Una lama dentellata
 Una hoja dentada
 Une lame dentelée

IRIS
FM-100
110 mm

METZENBAUM
FM-102
145 mm

LA GRANGE
LG-1SC
115 mm



Eine Schneide gezahnt - One toothed cutting edge
Una lama dentellata - Una hoja dentada - Une lame dentelée

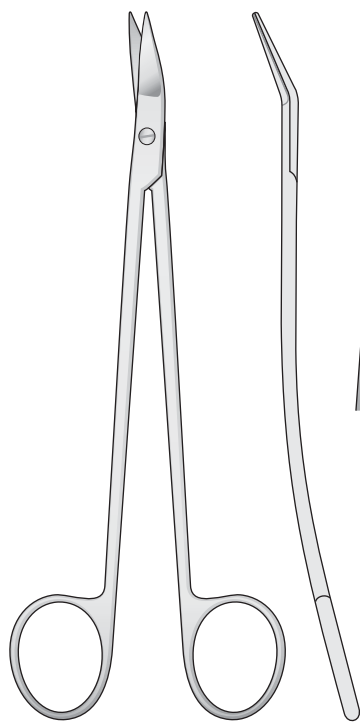

DEAN
DEAN
180 mm

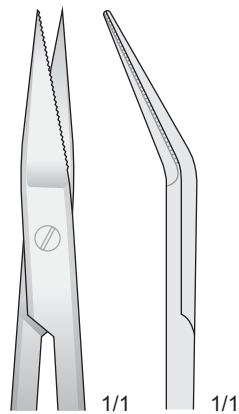

1/1

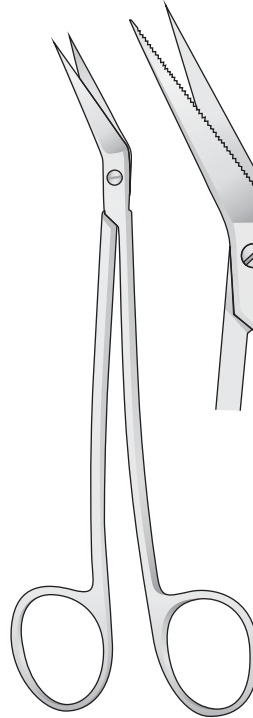

LOCKLIN
LK-2
160 mm

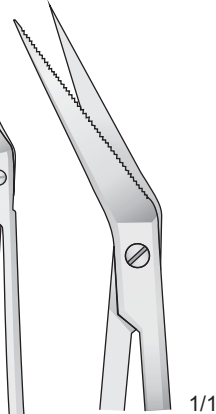

1/1

Drahtschere
Wire Cutting Scissors
Forbici per fili
Tijeras para Alambre
Ciseaux à fils

TC

TC

Ligaturscheren - Suture Scissors
Forbici per suture - Tijeras pad 1fura ligaduras
Ciseaux pour sutures

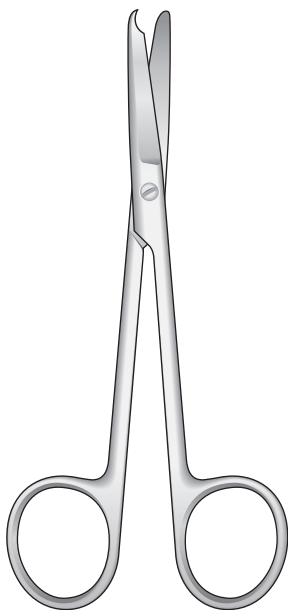

SPENCER
SC-14
120 mm

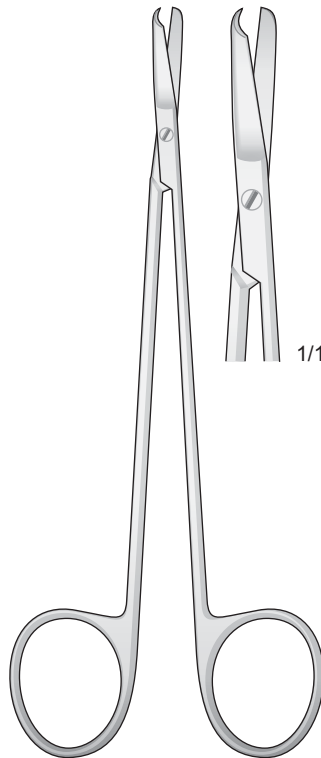

KELLY
SC-16
150 mm



1/1

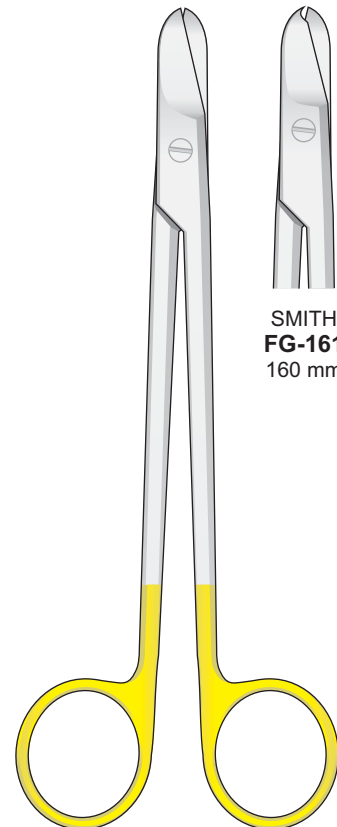

SMITH
FG-160
160 mm



SMITH
FG-161
160 mm



Chirurgische und Anatomische Pinzetten

Tissue Pliers and Dressing forceps

Pinzette chirurgiche e anatomiche

Pinzas quirùrgicas y anatómicas

Pinces chirurgicales et Anatomiques

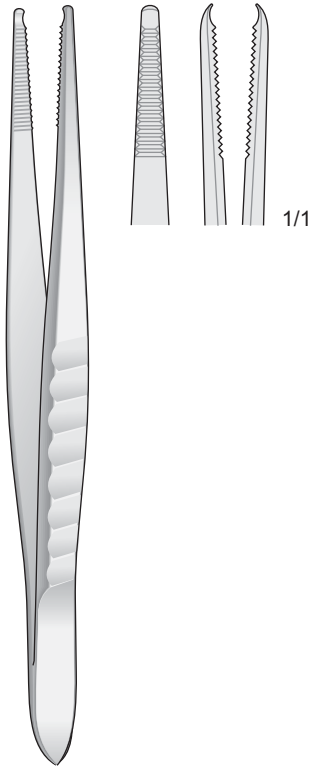

BD-270
130 mm

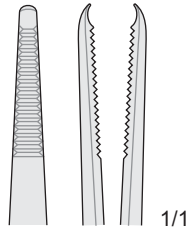

1/1



BD-351/BD-356

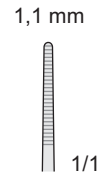

BD-351
125 mm

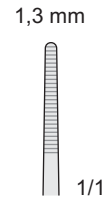

BD-352
150 mm

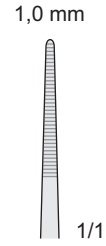

BD-353
175 mm

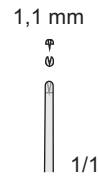

BD-354
125 mm

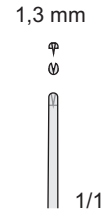

BD-355
150 mm

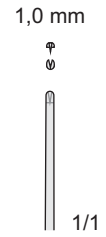

BD-356
175 mm

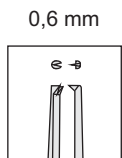

0,6 mm

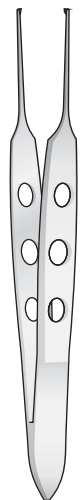

BISHOP-HARMON
MF-177
85 mm



CORN
DA-07
150 mm

Nahtpinzetten
zum Halten von Gewebe
und Membranen
Suture Pliers
for holding Tissue
and Membranes
Pinzette per sutura
per tenere fermi
tessuti e membrane
Pinzas de sutura
para sostener
tejidos y membranas
Pince de suture
pour le maintien de
tissus et de membranes

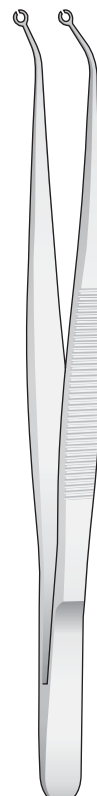

Ø Int 1.6 mm



1/1

BD-158

Ø Int 2.2 mm



1/1

BD-159

Nahtpinzetten
Suture Pliers
Pinzette per sutura
Pinzas de sutura
Pince à suture

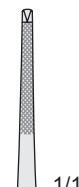

BD-280
150 mm

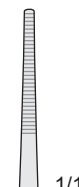

BD-284
150 mm



GILLIES
BD-280/BD-284
150 mm



Mit Hartmetalleinlage
With Tungsten-carbide inserts
Con inserti al carburo di tungsteno
Pinzas con plaquitas de carburo de tungsteno
Avec plaquettes en carbure de tungstène

Mikro diamantiertes Maul
Micro Diamond Jaw
Micro punta diamantata
Micro boca diamantada
Micro mors diamanté

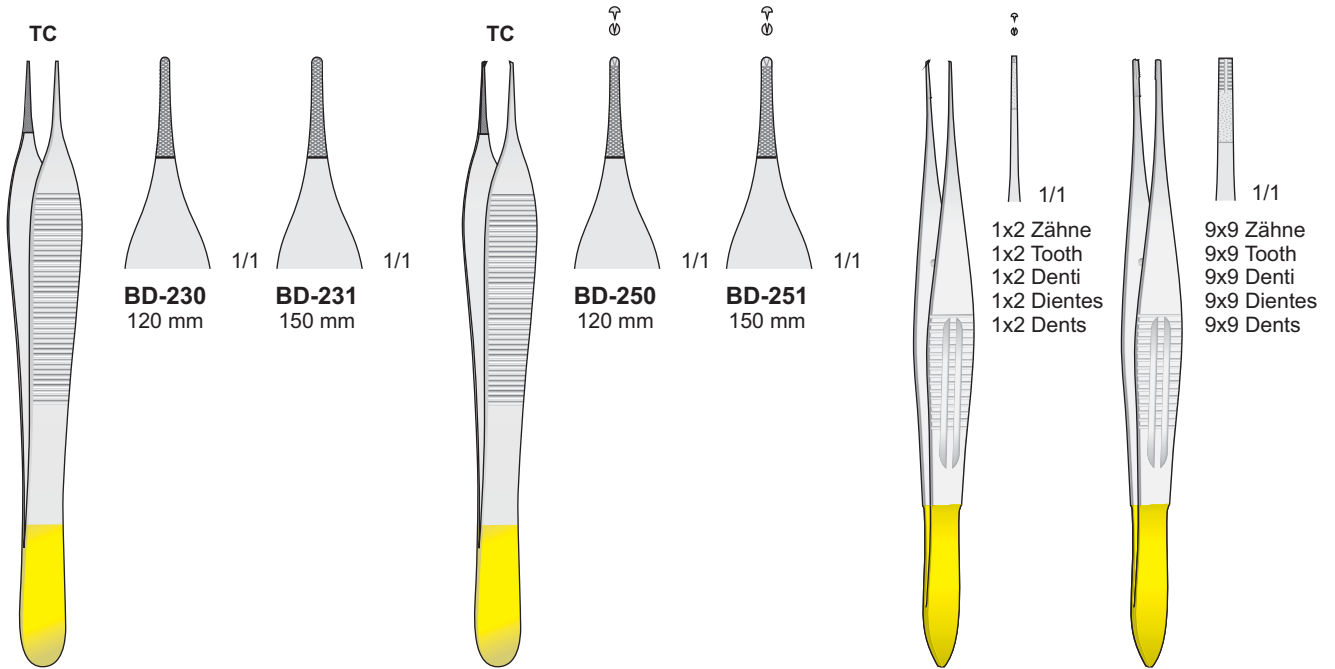

ADSON
BD-230/BD-231

ADSON
BD-250/BD-251

CASTROVIEJO
BD-348 0.9 mm
120 mm

BROWN
BD-349
120 mm

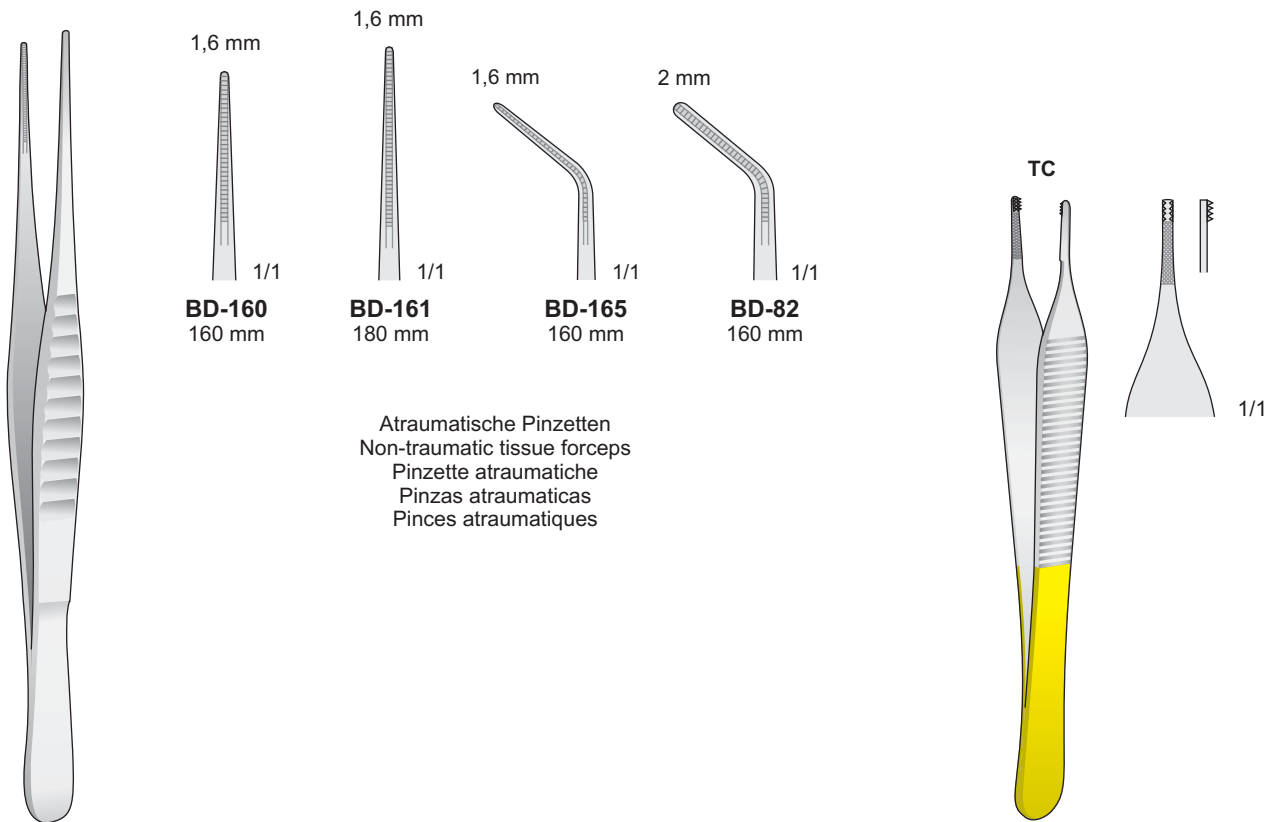

DE BAKEY
BD-82/BD-165

ADSON-BROWN
BD-253
120 mm

Atraumatische Pinzetten
Non-traumatic tissue forceps
Pinzette atraumatiche
Pinzas atraumaticas
Pinces atraumatiques



Chirurgische und
Anatomische Pinzetten

Tissue Pliers and
Dressing forceps

Pinzette chirurgiche
e anatomiche

Pinzas quirúrgicas
y anatómicas

Pincas quirúrgicas
et Anatomiques

Pinzette zum Halten Membranen
Membrane Holding forceps
Pinza per fissaggio membrane
Pinza para sostener membranas
Pince pour le maintien membranes

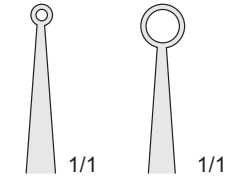

BD-56

BD-57

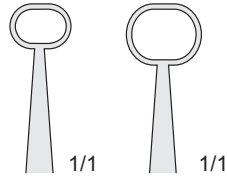

BD-58

BD-59

BD-56/BD-59
100 mm

Surgical Retractor

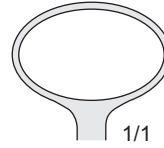
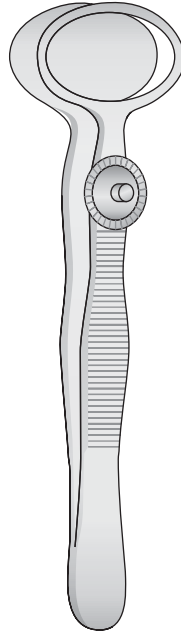

BD-130
20 mm

DESMARRES
BD-130
90 mm

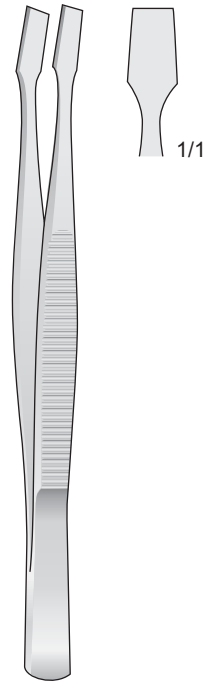

KÜHNE
ES-44
105 mm

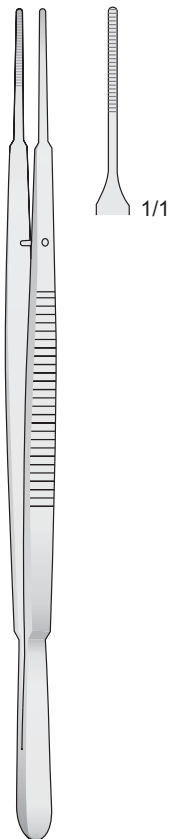

GERALD
MF-101
180 mm

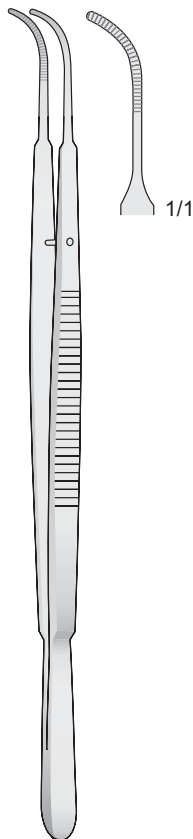

GERALD
MF-102
180 mm

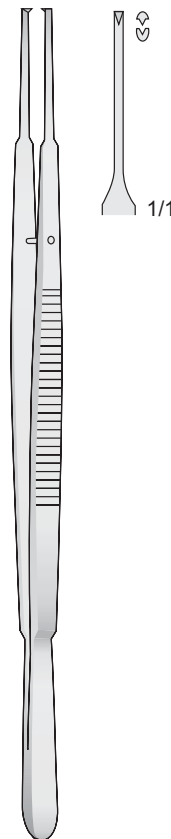

GERALD
MF-103
180 mm

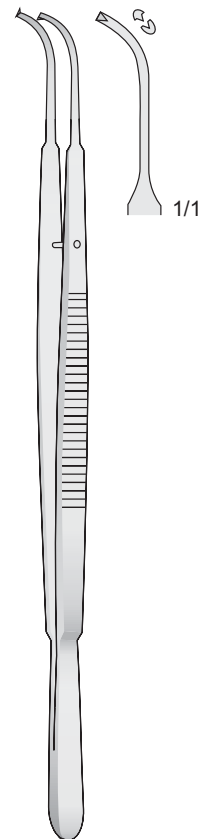

GERALD
MF-104
180 mm



Titan - Titanium - Titanio - Titane

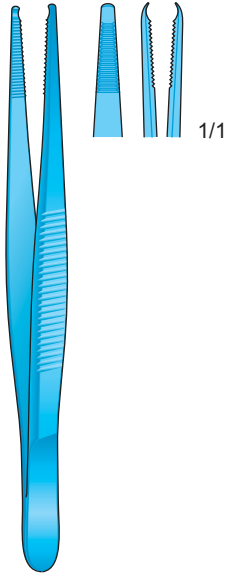

BD-285T
90 mm



BD-270T
130 mm

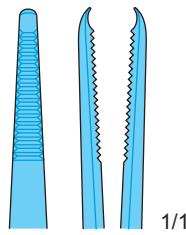

ADSON
BD-30T
120 mm

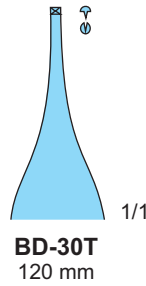

ADSON
BD-31T
120 mm

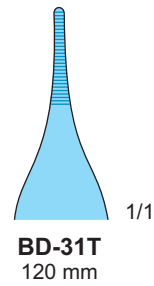

BD-09T
130 mm

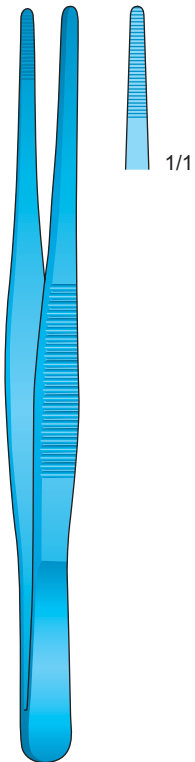

BD-75T
145 mm

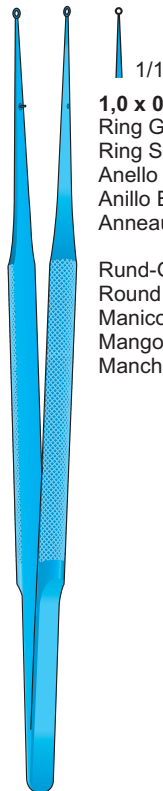

MF-342T
150 mm

1,0 x 0,5 mm
Ring Gerieft
Ring Serrated
Anello Zigrinato
Anillo Estriadas
Anneau Stries

Rund-Griffe Ø 8 mm
Round handle Ø 8 mm
Manico rotondo Ø 8 mm
Mango redondo Ø 8 mm
Manche rond Ø 8 mm

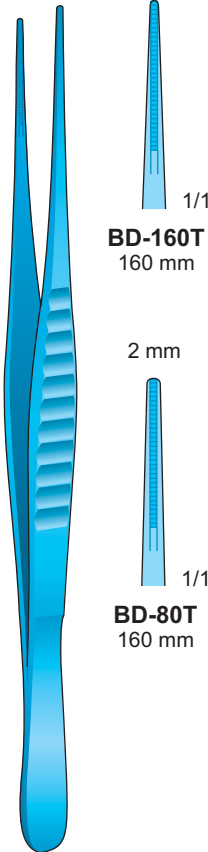

DE BAKEY
BD-80T/BD-160T
160 mm

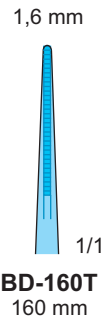

BD-160T
160 mm

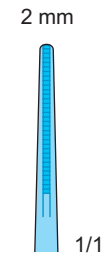

BD-80T
160 mm

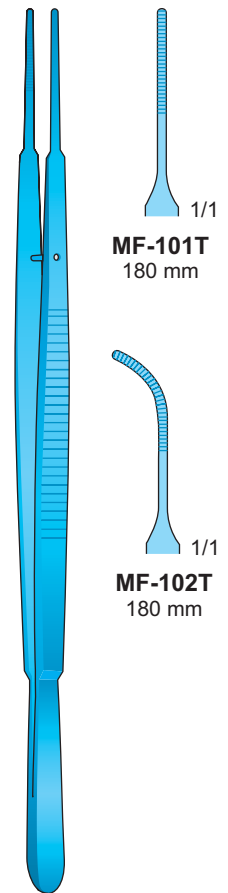

GERALD
MF-101T/MF-102T
180 mm

MF-101T
180 mm

MF-102T
180 mm

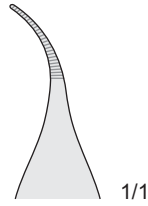

Extra fein
Extra fine
Extra fine
Extra finas
Extra feins

Gebogen
Curved
Curva
Curva
Courbes

MICRO-ADSON
BD-372
120 mm

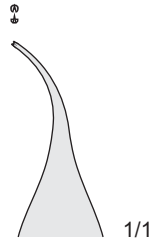

Extra fein
Extra fine
Extra fine
Extra finas
Extra feins

Gebogen
Curved
Curva
Curva
Courbes

1x2 Zähne
1x2 Tooth
1x2 Denti
1x2 Dientes
1x2 Dents

MICRO-ADSON
BD-373
120 mm

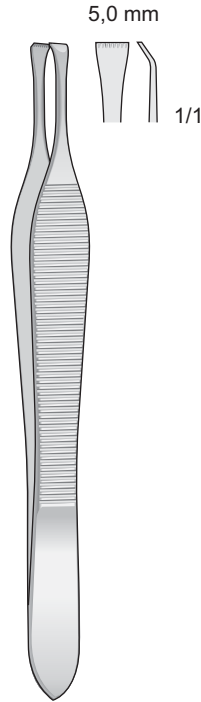

BEASLEY-BABCOCK
BD-51
120 mm

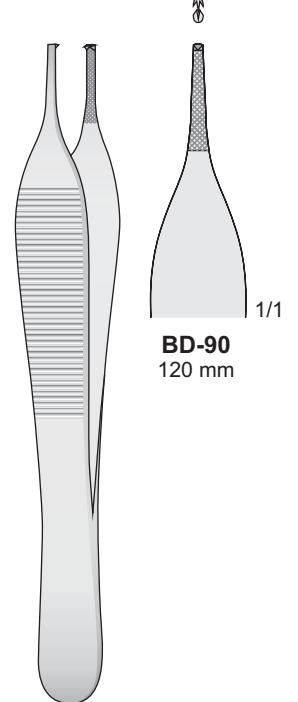

BD-90
120 mm

ADSON
BD-90
120 mm

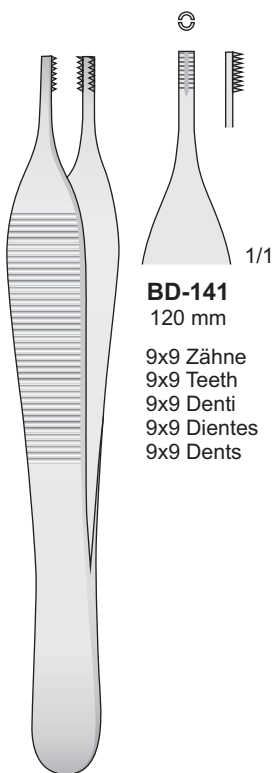

BD-141
120 mm

9x9 Zähne
9x9 Teeth
9x9 Denti
9x9 Dientes
9x9 Dents

ADSON-BROWN
BD-141
120 mm

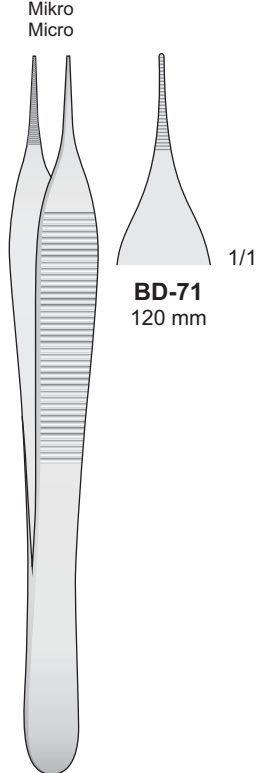

BD-71
120 mm

ADSON
BD-71
120 mm

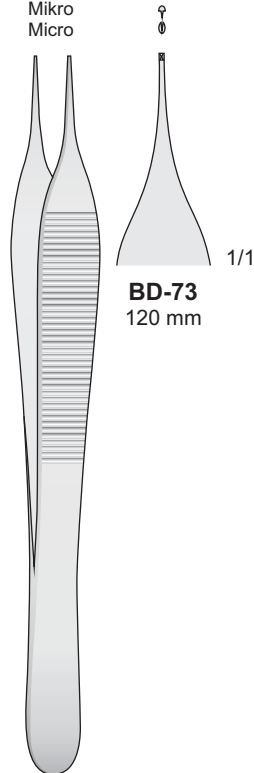

BD-73
120 mm

ADSON
BD-73
120 mm

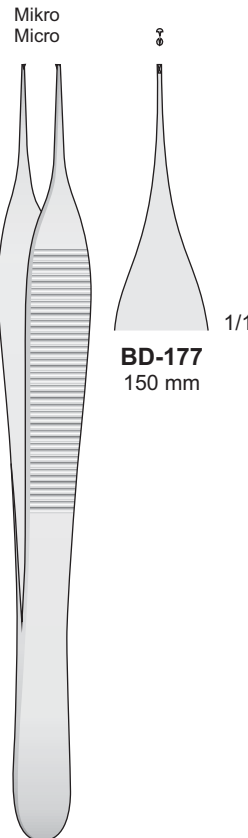

BD-177
150 mm

ADSON
BD-177
150 mm

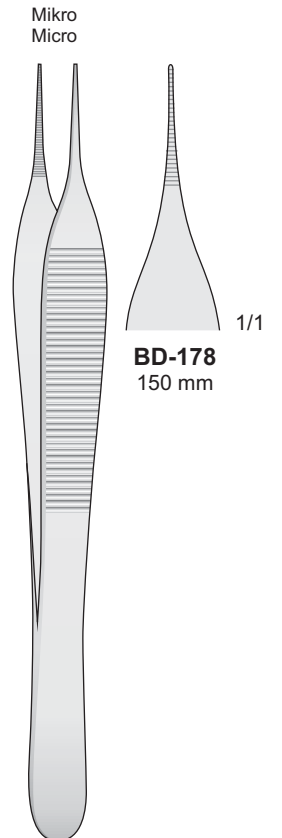

BD-178
150 mm

ADSON
BD-178
150 mm



Mikro-Chirurgie - Micro Surgical
Micro Chirurgia - Micro Cirurgia
Micro Chirurgie

Titan - Titanium
Titanio - Titane

Rund-Griffe Ø 8 mm - Round handle Ø 8 mm
Manico rotondo Ø 8 mm - Mango redondo Ø 8 mm
Manche rond Ø 8 mm

Mikro Nadelhalter
Micro Needle Holders
Micro port'aghi
Micro portaagujas
Micro porte aiguilles

Mikro Scheren
Micro Scissors
Micro forbici
Micro Tijeras
Micro ciseaux

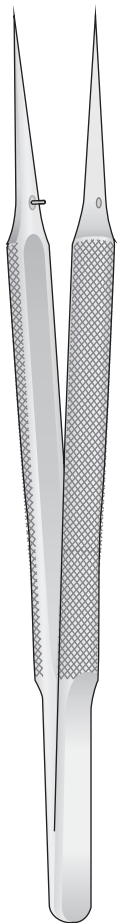
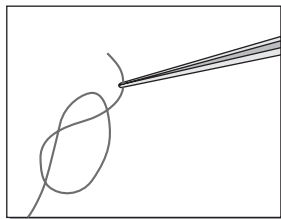

MF-112
150 mm

MF-113
150 mm

MF-114
180 mm

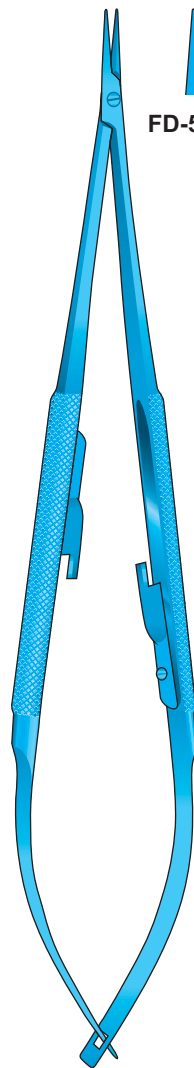
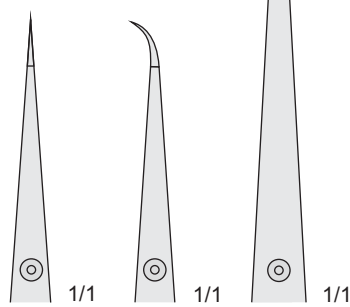

FD-574T/FD-575T
180 mm

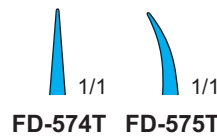

FD-574T 1/1 **FD-575T** 1/1

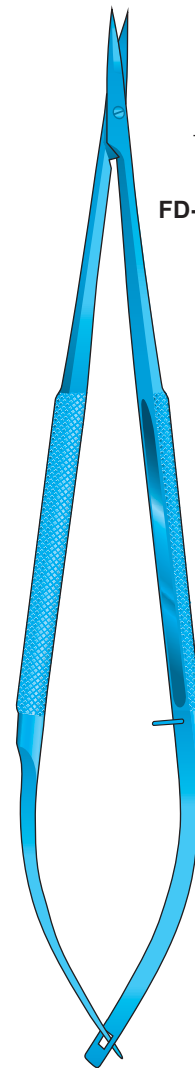

FD-587T/FD-588T
180 mm

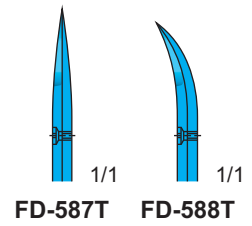

FD-587T 1/1 **FD-588T** 1/1



Mikro-Chirurgie - Micro Surgical
Micro Chirurgia - Micro Cirugia
Micro Chirurgie

Nadelhalter mit Hartmetalleinlagen
Needle Holders with tungsten-carbide inserts
Portaghi con inserti al tungsteno
Portaagujas con plaquitas de carburo de tungsteno
Porte aiguilles avec plaquettes en carbure de tungstène

Mit glatten maul
With smooth jaws
Con morso liscio
Con mandibula lisa
Avec mors lisses

TC

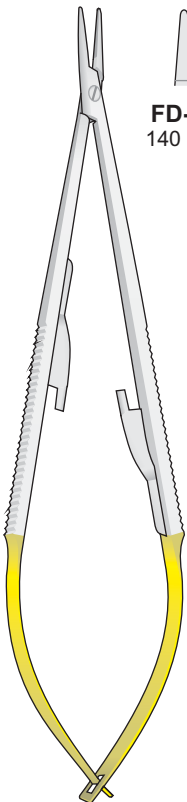

CASTROVIEJO
FD-21/FD-28
140 mm

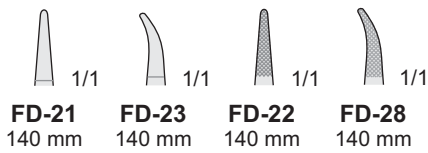

TC

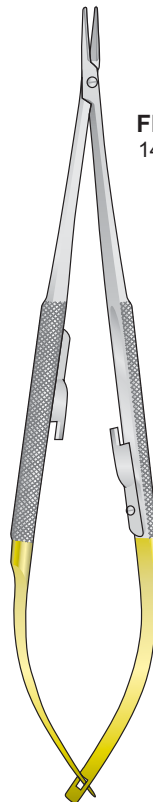

CASTROVIEJO
FD-170/FD-171
140 mm

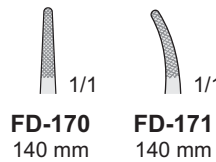

TC

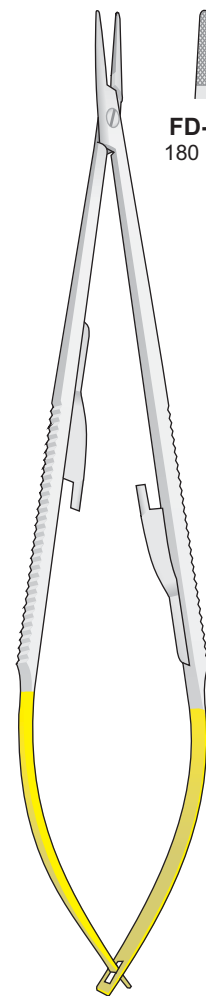

CASTROVIEJO
FD-25/FD-29
180 mm

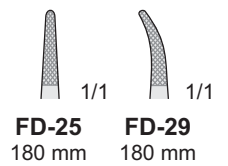



Nadelhalter mit Hartmetalleinlagen
 Needle Holders with tungsten-carbide inserts
 Portaghi con inserti al tungsteno
 Portaagujas con plaquitas de carburo de tungsteno
 Porte aiguilles avec plaquettes en carbure de tungstène

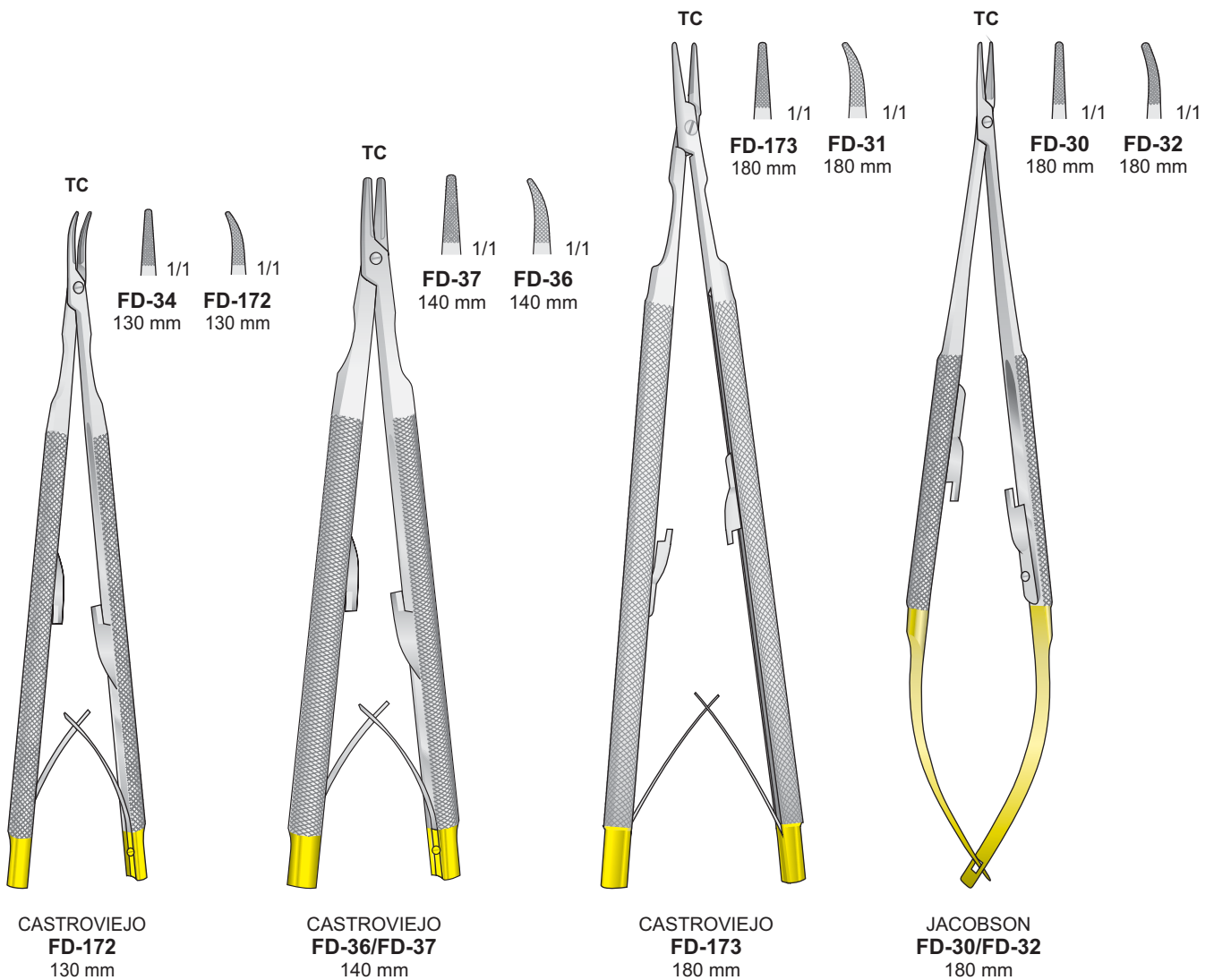



Nadelhalter

Needle holders

Port'aghi

Portaagujas

Porte aiguilles

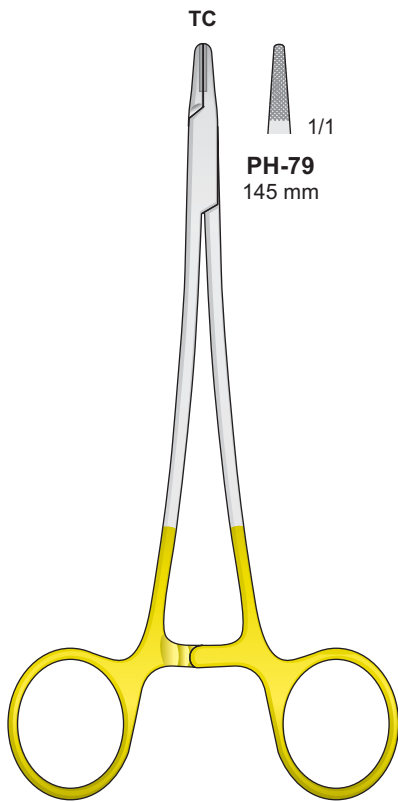

PH-79
145 mm

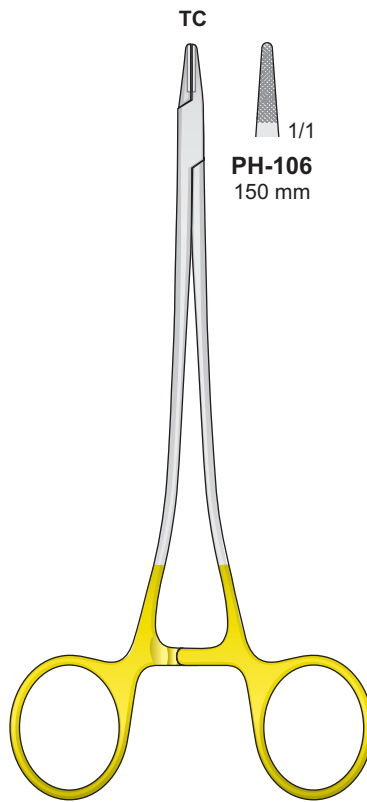

SWEDISH MOD.
PH-106
150 mm

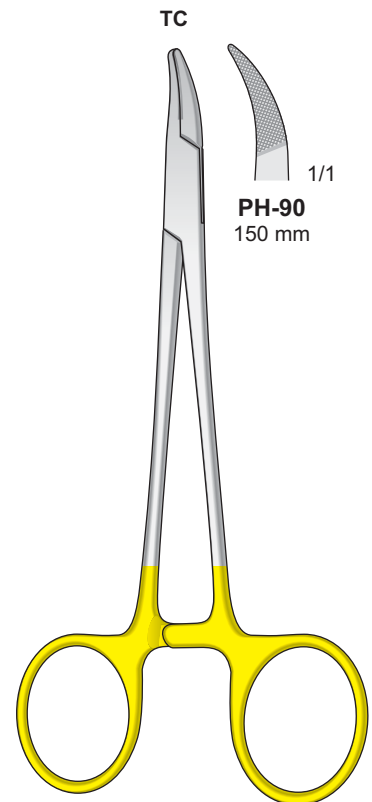

CRILE-WOOD
PH-90
150 mm

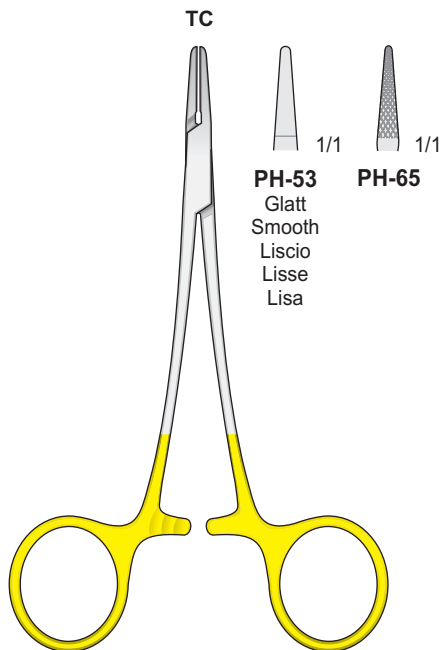

PH-53/PH-65
120 mm

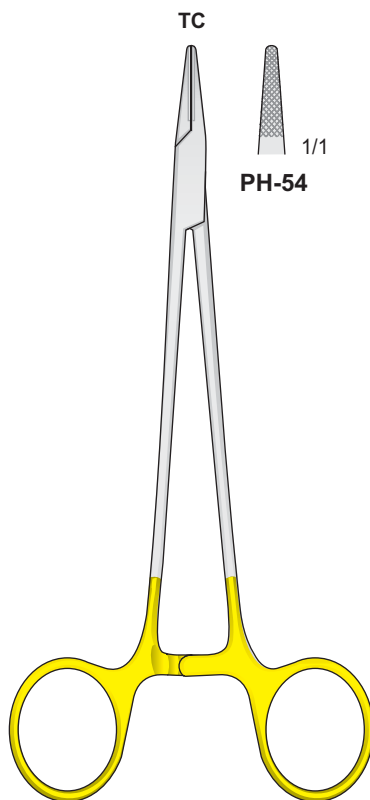

BABY-CRILE-WOOD
PH-54
150 mm

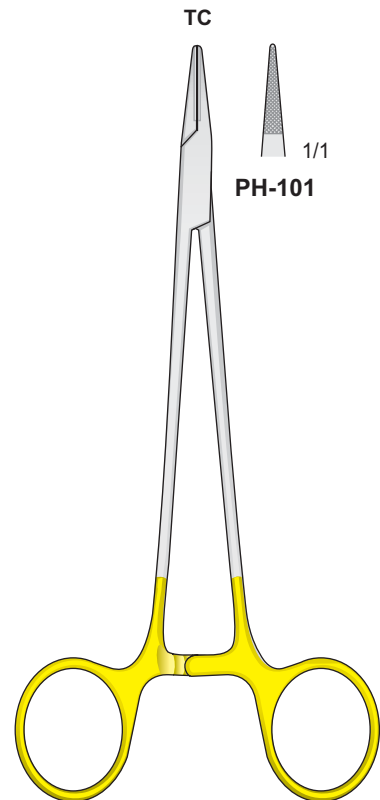

MICRO-VASCULAR
PH-101
150 mm

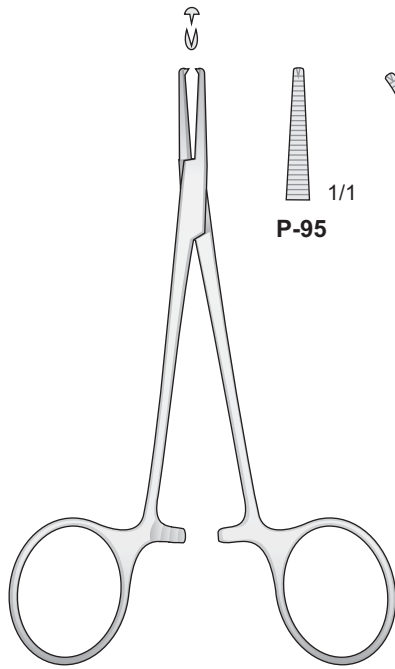

HALSTED-MOSQUITO
P-95/P-98
120 mm

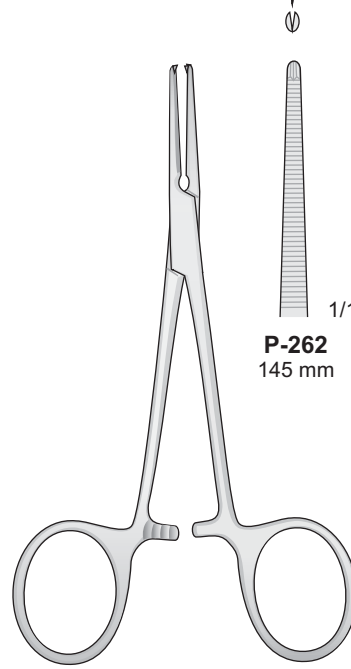
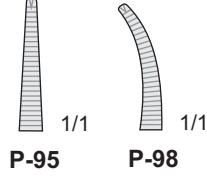

KOCHER
P-262/P-263
145 mm

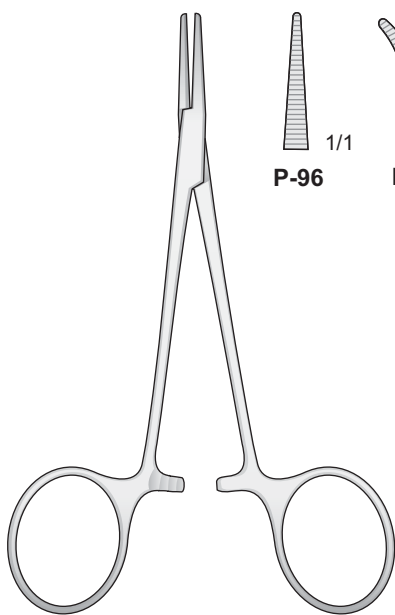
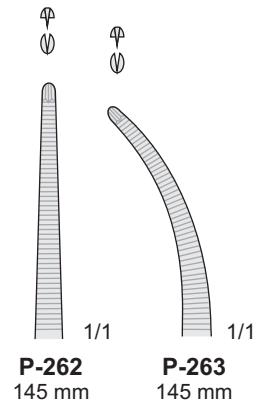

HALSTED-MOSQUITO
P-96/P-97
120 mm

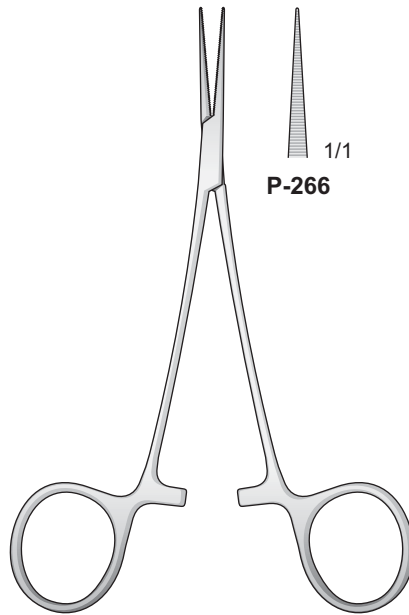
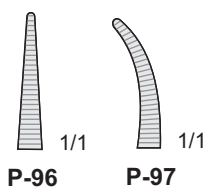

JACOBSON-MICRO
P-266
130 mm

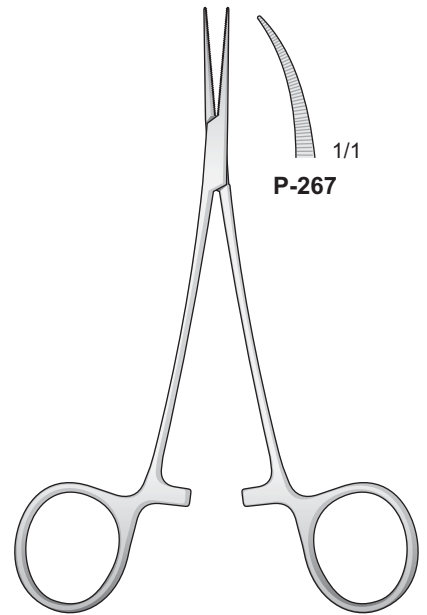
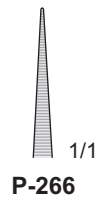

JACOBSON-MICRO
P-267
130 mm

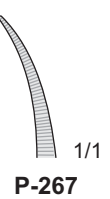



Skalpellsklingen
und Skalpellgriffe

Scalpel Blades and
Scalpel handles

Lame per bisturi
Manici per bisturi

Hojas de bisturis
Mangos de bisturis

Lames de bistouris
Manches de bistouris

Steril - Sterile - Sterili - Estériles - Stériles

Fig. 15



LB-15

Packung 100 Klingen
Package 100 blades
Confezione da 100 lame
Cajita de 100 lames
Boite de 100 lame

Mikro-Klingen - Micro blades
Microlame - Microhojas - Micro lames



LB-361



LB-362



LB-363



LB-364



LB-367

Packung 10 Klingen
Package 10 blades
Confezione da 10 lame
Cajita de 10 lames
Boite de 10 lame

Rhodium Spiegel
Specchietto rodiato
Espejo de rodio
Miroir au rhodium
Ø 24 mm



RH-5

Packung 12 Spiegel
Package 12 mirrors
Confezione da 12 specchi
Cajita de 12 espejos
Boite de 12 miroirs

Für Mikro-Skalpellsklingen
For Micro Scalpel blades
Per Microlame
Para Microhojas
Pour Micro lames



NK-11
125 mm

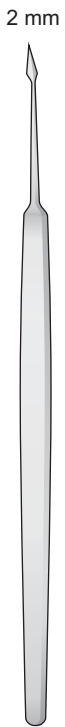

NK-17
125 mm

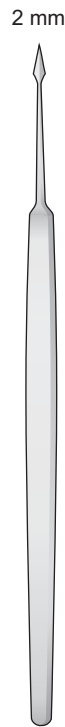

NK-39
125 mm



NK-2
150 mm



BB-46
135 mm



BB-48
155 mm



MA-B1
Fig. 5



MA-B3M
Fig. 3M

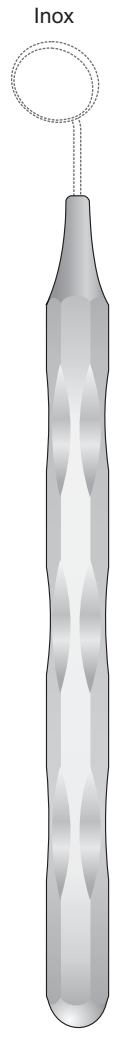

MA-7
135 mm



Mikrochirurgische Spiegel und Halter
 Microsurgical mirrors and holder
 Specchietti per Microchirurgia e manico
 Espejos de microcirugia y mango
 Miroirs de microchirurgie et manche

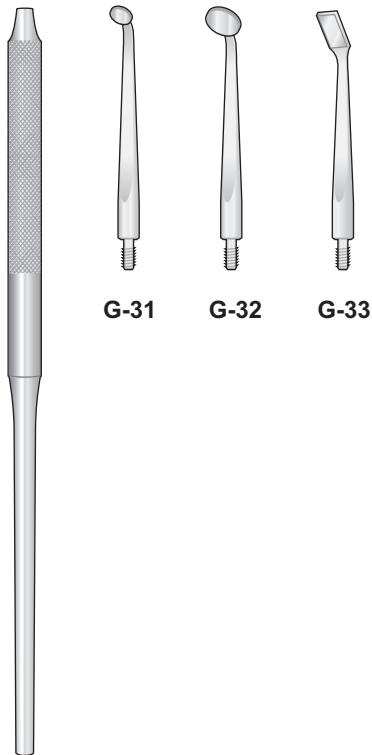

G-31 **G-32** **G-33**

MA-2

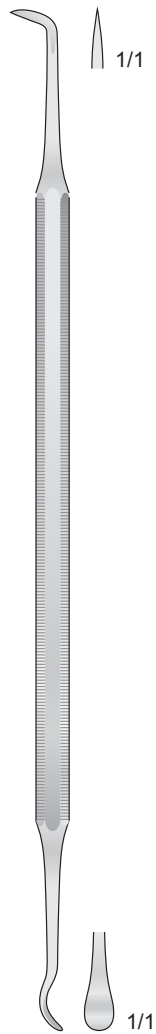

MITCHEL
AT-12
170 mm

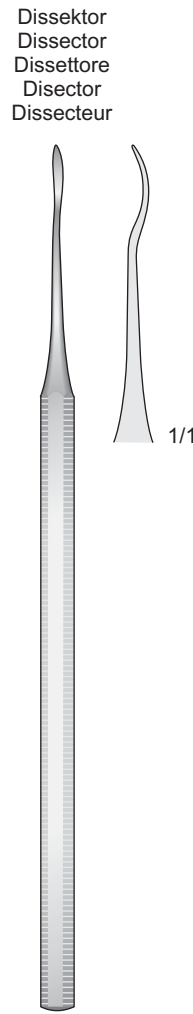

ES-13
135 mm

Periotome - Periotomes
 Periotomi - Periostótomos
 Périotomes

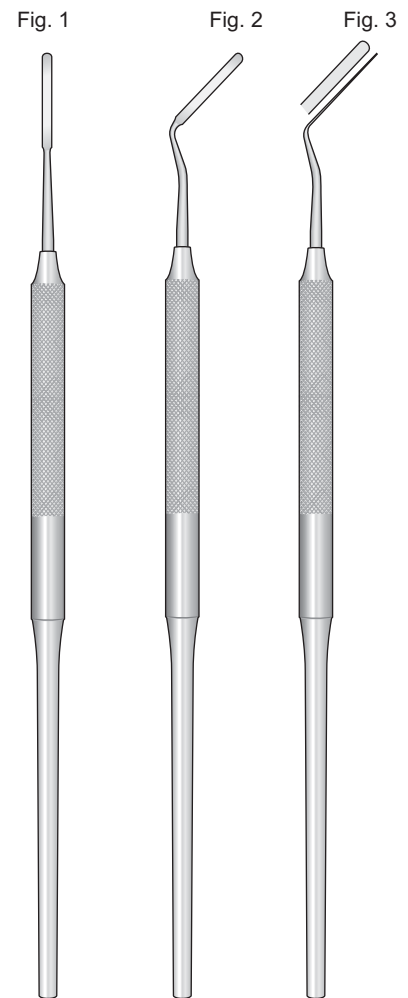

MC-11 **MC-12** **MC-13**
160 mm 160 mm 160 mm



Meßbereich: 0 - 80 mm
Measuring range: 0 - 80 mm
Campo di misura: 0 - 80 mm
Alcance de medición: 0 - 80 mm
Etendue de mesure: 0 - 80 mm

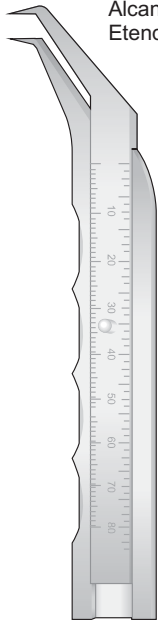

OR-40
125 mm

0,5 mm



LS-08
100 mm

0,5 mm



LS-09
150 mm

Implant Graduierung
Implant depth gauge with ball end
Sonda per controllare la profondità del sito
Sonda para controlar la profundidad

Ø 2.0 mm



GA-60
100 mm

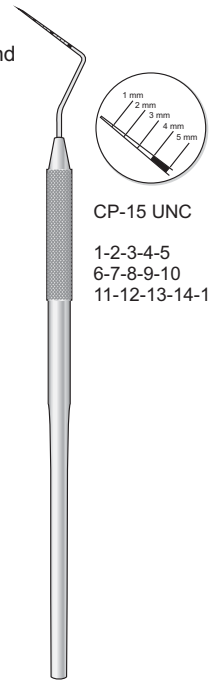

CP-15 UNC

1-2-3-4-5
6-7-8-9-10
11-12-13-14-15

SM-15
155 mm

Meßbereich: 0 - 40 mm
Measuring range: 0 - 40 mm
Campo di misura: 0 - 40 mm
Alcance de medición: 0 - 40 mm
Etendue de mesure: 0 - 40 mm

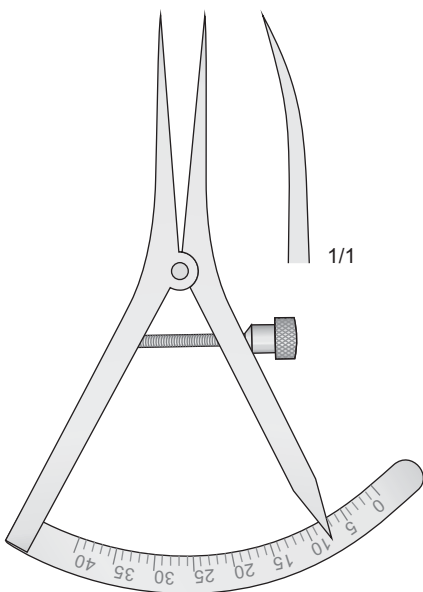

CASTROVIEJO
OR-13
90 mm

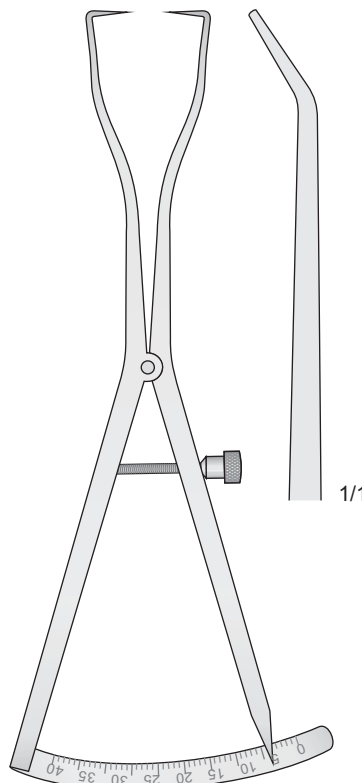

CASTROVIEJO
OR-18
170 mm

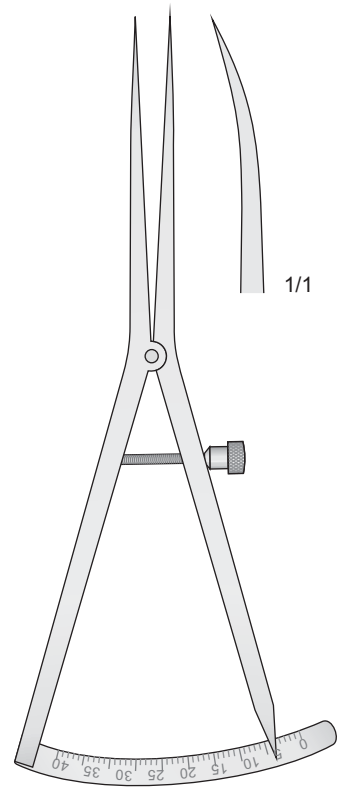

CASTROVIEJO
OR-14
170 mm



Mundsperrer
Wundhaken

Mouth Gags
Retractors

Apribocca
Divaricatori

Abrebocas
Separadores

Écarteur buccal
Écarteurs

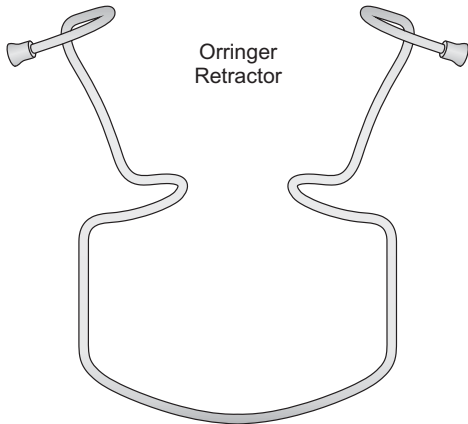
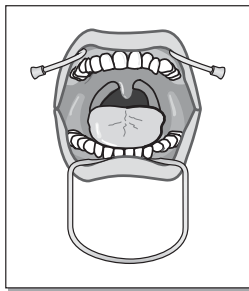

Orringer
Retractor

- OM-74** Fig. 0 100 x 95 mm
- OM-75** Fig. 1 115 x 105 mm
- OM-76** Fig. 2 115 x 110 mm
- OM-77** Fig. 3 125 x 115 mm

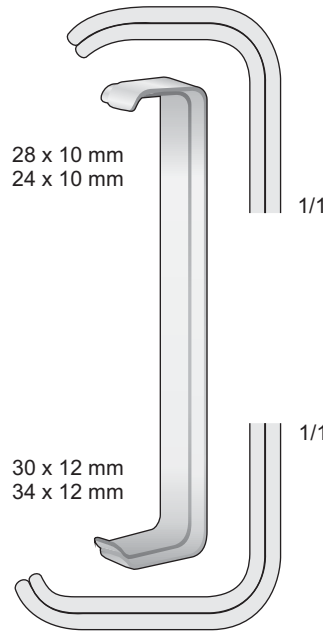

28 x 10 mm
24 x 10 mm

30 x 12 mm
34 x 12 mm

FARABEU F
BT-20
120 mm

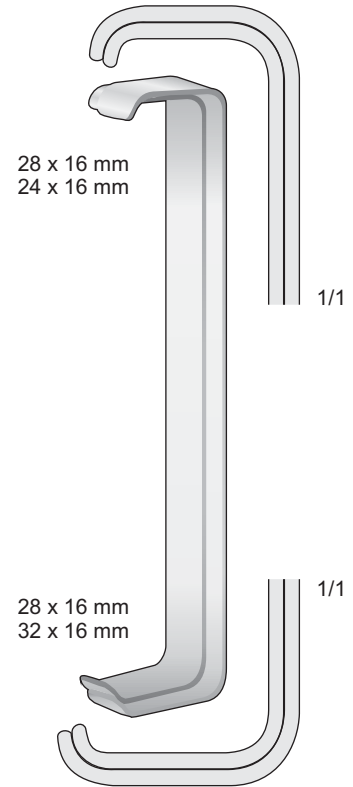

28 x 16 mm
24 x 16 mm

28 x 16 mm
32 x 16 mm

FARABEU F
BT-25
150 mm

Abhalter für gesamten Ober- bzw. Unterkiefer - Retractor for complete upper resp. Lower jaws
Retrattore per arcata superiore e inferiore intera - Separadores para quijadas enteras inferiores y superiores
Écarteurs pour machoires complètes inférieures et supérieures

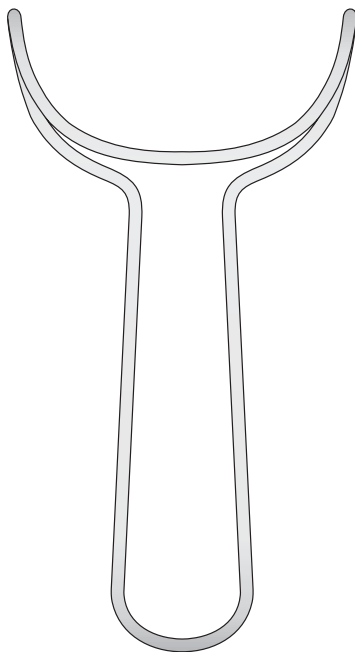

OM-90
150 mm

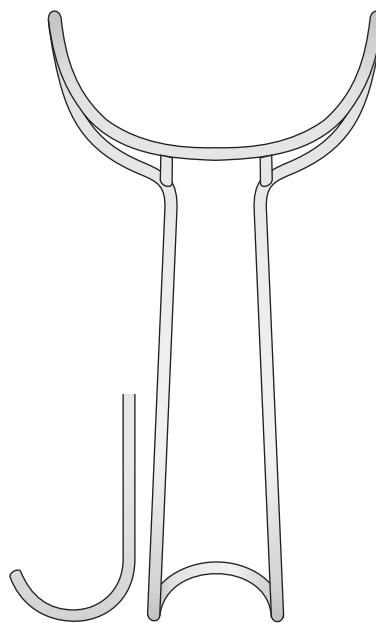

OM-91
140 mm

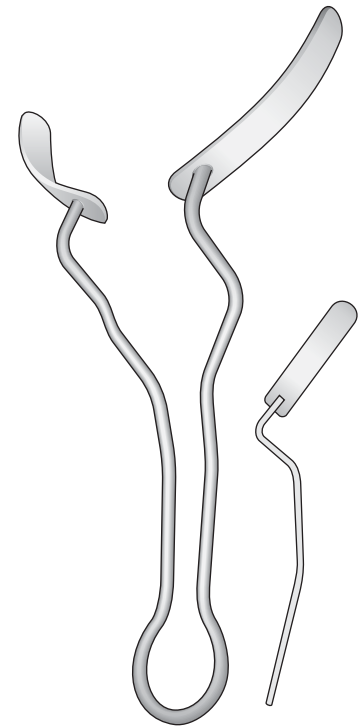

MATY
OM-97
170 mm



Wangenhalter
Zungenspatel

Cheek Retractors
Tongue depressor

Divaricatori per guance
Abbassalingua

Separadores para mejillas
Abaja lenguas

Écarteurs des joues
Abaisse-langue

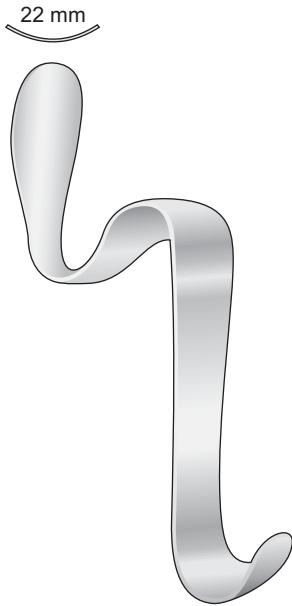

BISHOP
OM-61
130 mm



MINNESOTA
OM-55
140 mm

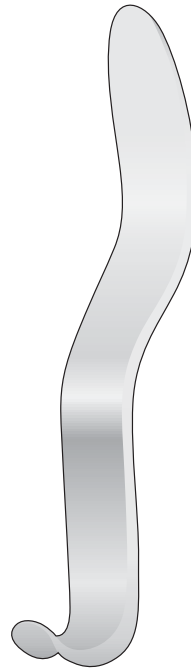

CAWOOD-MINNESOTA
OM-66
160 mm

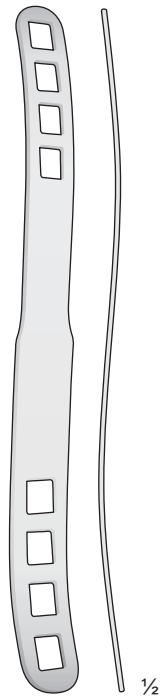

BRUENINGS
OM-04
190 mm

Rostfrei - Stainless Steel - Acciaio - Acero - Acer
Biegsam - Malleable - Malleabili - Maleables - Malléable

Schwarz Verchromt - Black anodized
Cromato nero - Cromado en negro
Chromé noir



OM-87
200 mm

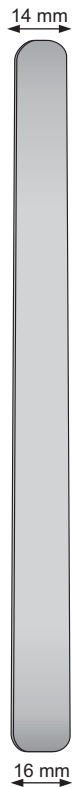

OM-88
200 mm



OM-80
200 mm



OM-81
200 mm

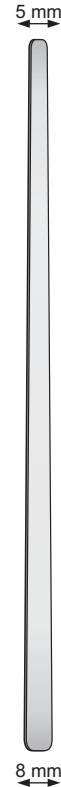

OM-82
240 mm

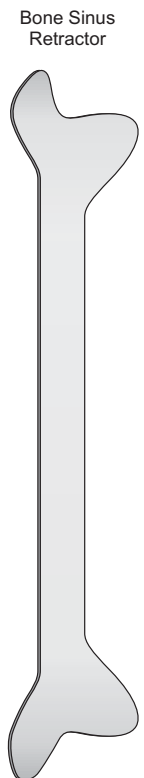

Bone Sinus
Retractor
OM-100
180 mm



Zungen und Wangenhalter
Tongue and Cheek Retractor
Abbassalingua e divaricatore labiale
Retradores de mejillas y labios
Abaisse-langue et ecarteur

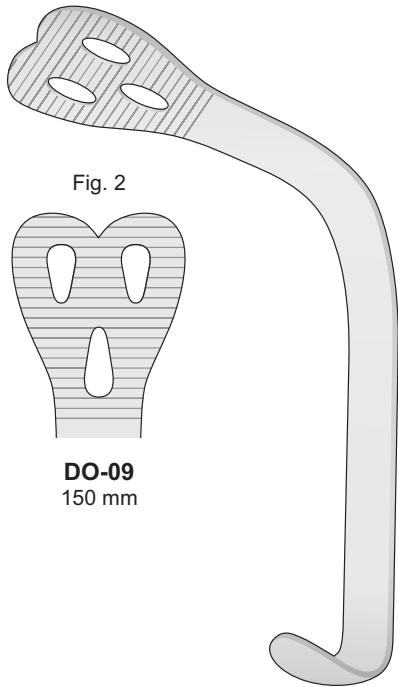
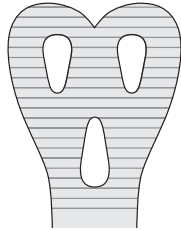

Fig. 2



DO-09
150 mm

WIEDER
DO-09
150 mm

Laryngoskop
Laryngoscope
Laringoscopio
Laringoscopio
Laryngoscope

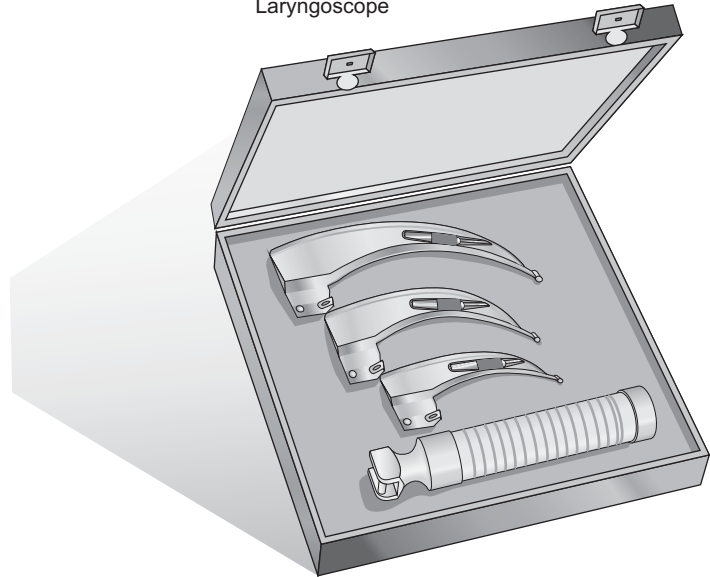

Mc INTOSH
AA-S103
Komplett - Complete
Completo - Completo
Completo

Zungenzangen
Tongue holding forceps
Pinza tiralingua
Pinzas tira-lengua
Pince tire-langue

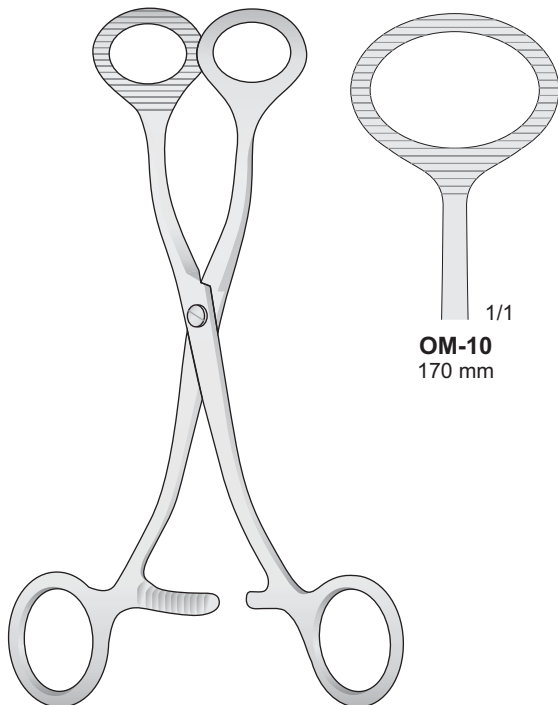

OM-10
170 mm

COLLIN
OM-10
170 mm

Kathetereinführungszangen
Catheter introducing forceps
Pinze da intubazione
Pinzas para introducir catéteres
Pinces pour introduire les sondes

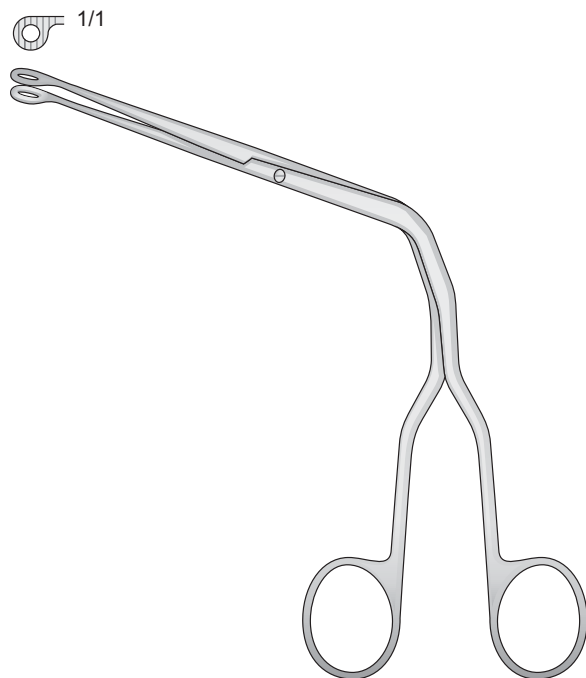

MAGILL
OM-12
150 mm



Retraktoren

Retractors

Divaricatori

Separadores

Écarteurs

Sinus Lift Retraktoren - Sinus Lift Retractors
Divaricatori per Sinus Lift - Separadores para Sinus Lift
Écarteurs pour Sinus Lift

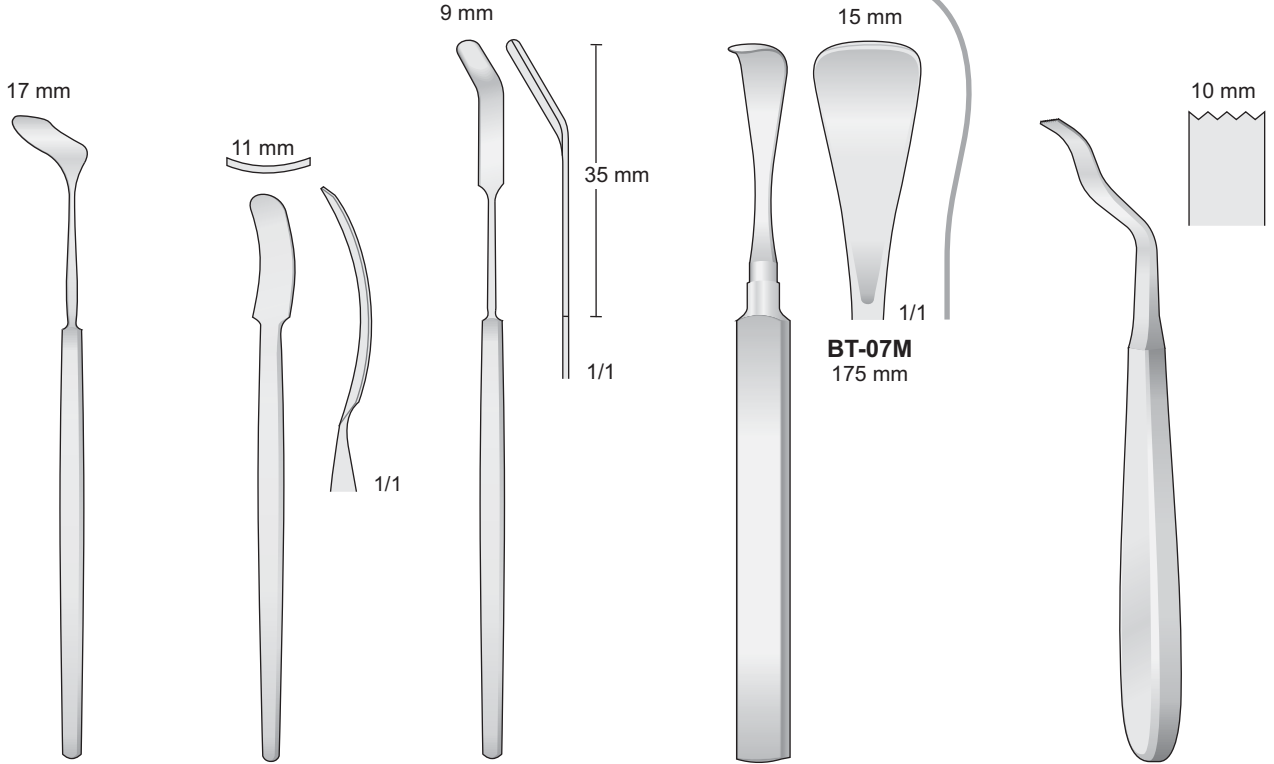

SAUTTER
NK-249
145 mm

NK-105
125 mm

MODELL GIESSEN
NK-251
160 mm

HENAHAN
BT-07M
175 mm

DO-204
170 mm

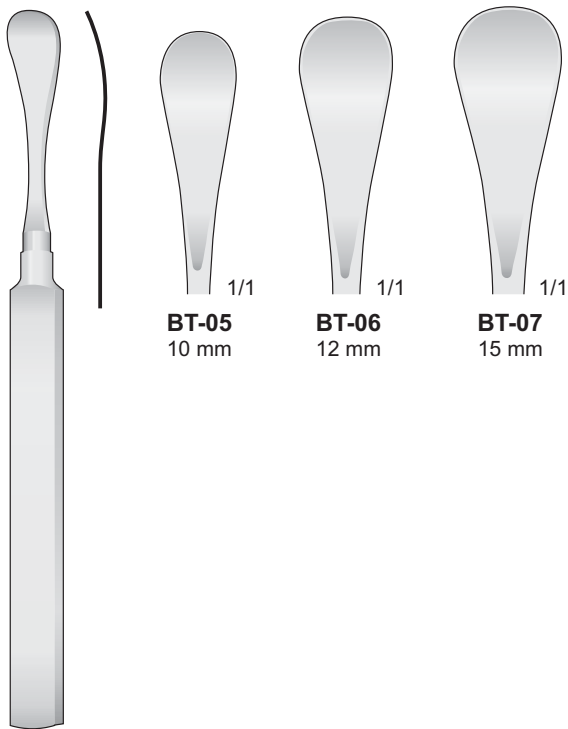

BT-05
10 mm

BT-06
12 mm

BT-07
15 mm

HENAHAN
BT-05/BT-07
175 mm

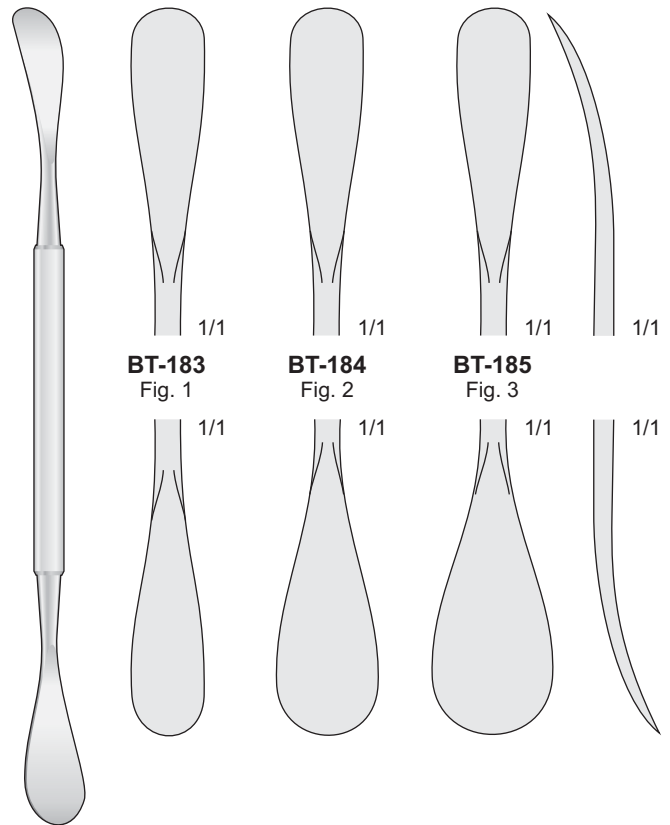

BT-183
Fig. 1

BT-184
Fig. 2

BT-185
Fig. 3

HENAHAN
BT-183/BT-185
200 mm



Wundhaken

Retractors

Divaricatori

Separadores

Écarteurs

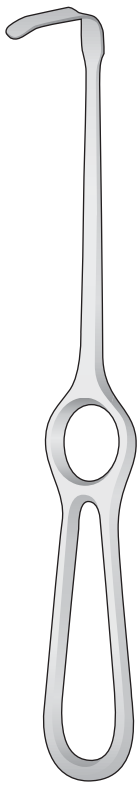

OBWEGESER
BT-94/BT-156
220 mm

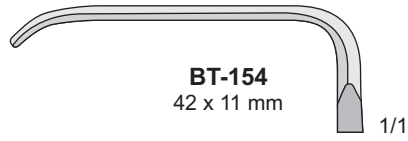

BT-154
42 x 11 mm

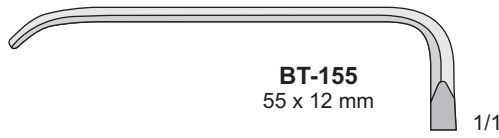

BT-155
55 x 12 mm

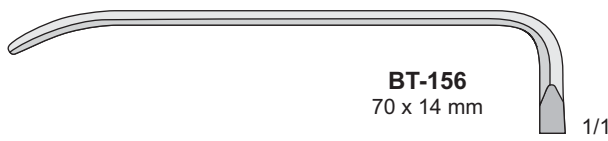

BT-156
70 x 14 mm

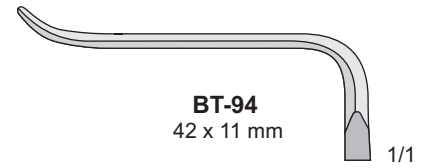

BT-94
42 x 11 mm

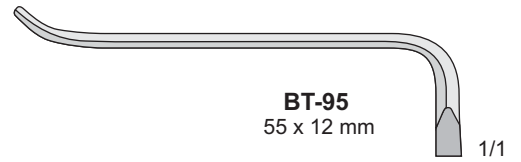

BT-95
55 x 12 mm

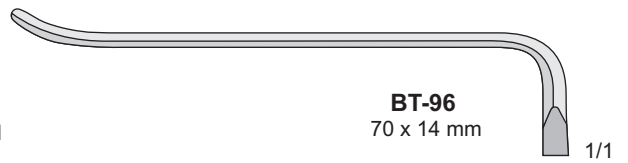

BT-96
70 x 14 mm

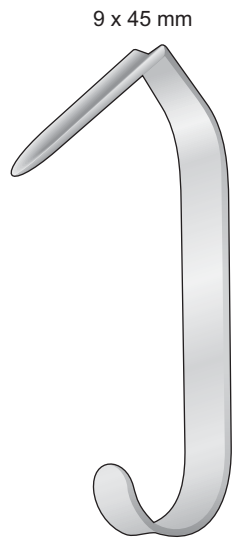

MALINIAC
DO-200
100 mm

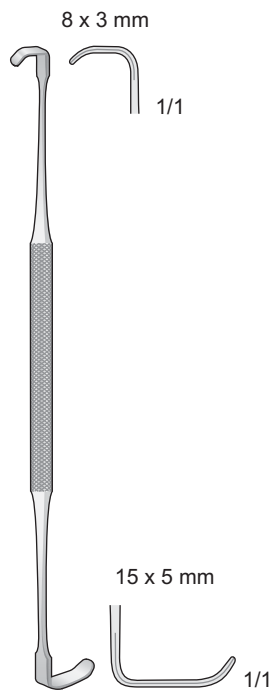

RAGNELL
BT-27
140 mm

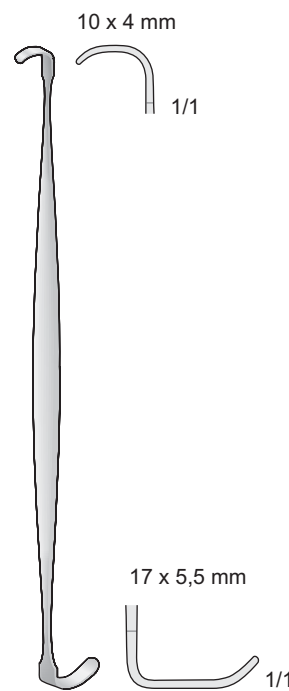

RAGNELL-DAVIS
BT-26
140 mm

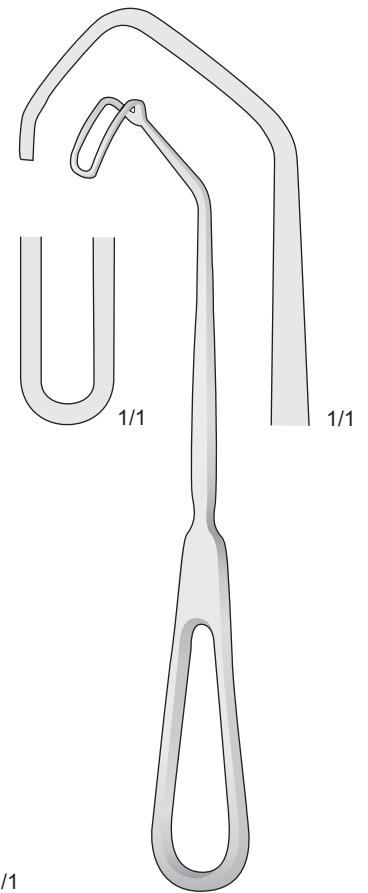

CUSHING
BT-29
200 mm



Tibia Wundspreizer
Tibial and Iliac Retractor
Divaricatore per tibia e cresta iliaca
Separadores para tibiales y iliacos
Ecarteur pour tibia e crête iliaque

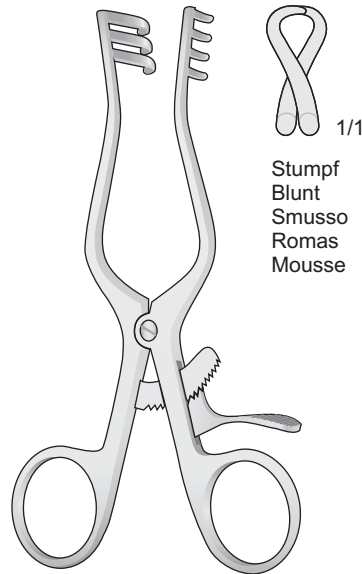

Stumpf
Blunt
Smusso
Romas
Mousse

WEITLANER
BV-23
165 mm

FK-105

Kompletset mit 4 Teilen - Set complete with 4 pieces
Set completo di 4 pezzi - Set completo con 4 piezas
Set complet avec 4 pièces

Combination Trocar-Trephine Instruments

Bestehend aus einem Trokar, einer gezahnten Trephine und einem Kolben zur Entnahme von Knochentransplantaten aus Tibia und Beckenkamm mittels eines geschlossenen Verfahrens

Consisting of trocar, a toothed trephine and a plunger for taking tibial and iliac bone grafts through a closed technique

Composto di un trequarti, una camicia dentata ed un pistone per il prelievo degli innesti ossei dalla tibia e dalla cresta iliaca tramite una tecnica chirurgica intracutanea

Compuesto por un trócar, un trépano dentado y un émbolo para obtener injertos óseos tibiales e iliacos mediante una técnica cerrada

Composé d'un trocart, d'une tréphine dentée et d'un piston pour le prélèvement de greffes osseuses de la tibia ou de la crête iliaque par une technique fermée

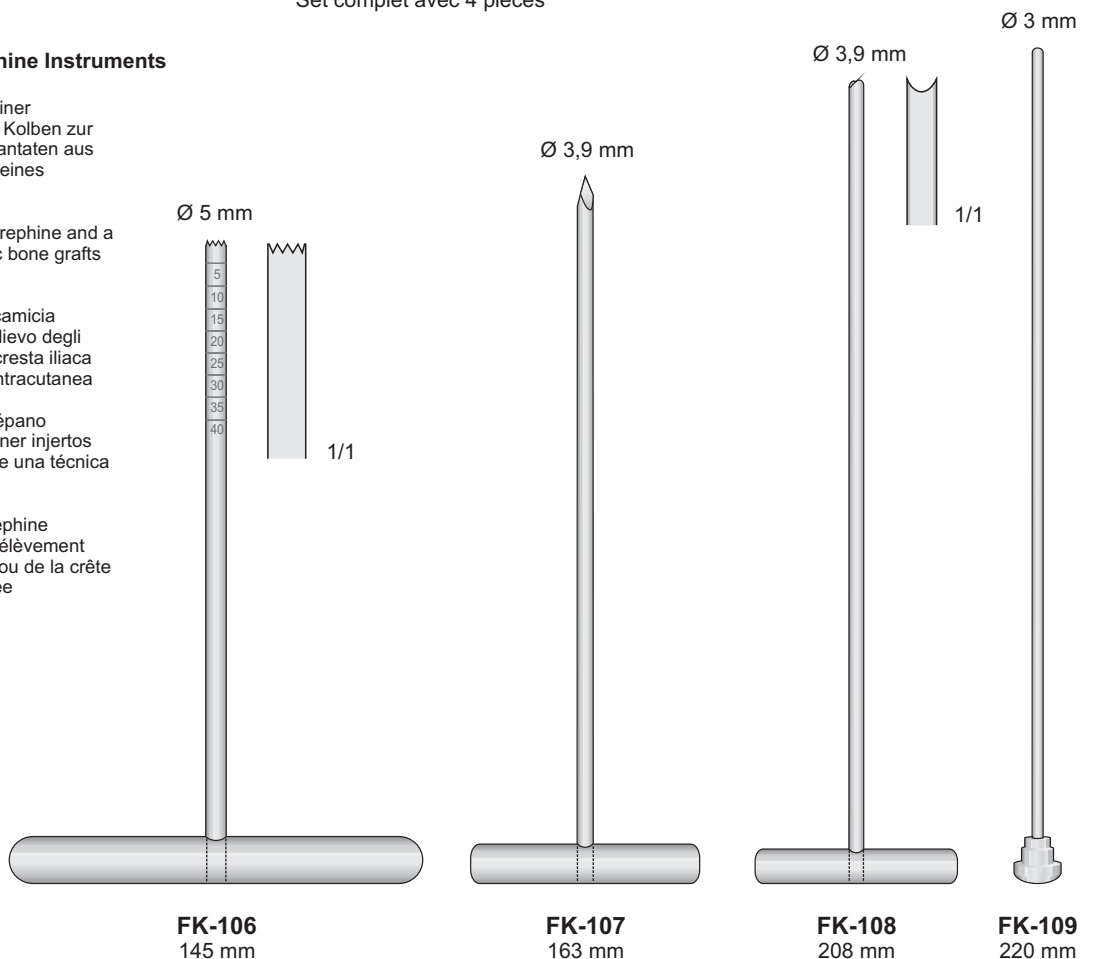



Raspatorien
Elevatorii

Periosteals
Elevators

Scollaperiosteai
Elevatori

Raspadores
Elevadores

Rugines
D colleurs

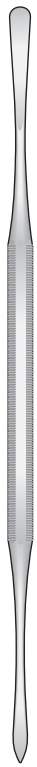

Stumpf
Blunt
Smusso
Mousse
Romo

ES-27
160 mm



Scharf
Sharp
Tagliente
Tranchant
Cortante

HB
160 mm



**MOLT
718-M9**
170 mm



**MOLT
MO-9A**
170 mm

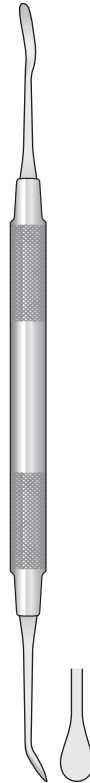

**WOODSON
712-241**
170 mm

1/1

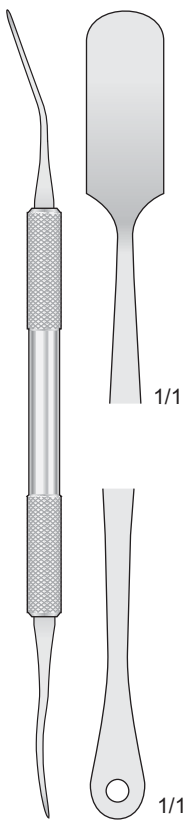

**PRICHARD
PR-3A**
180 mm

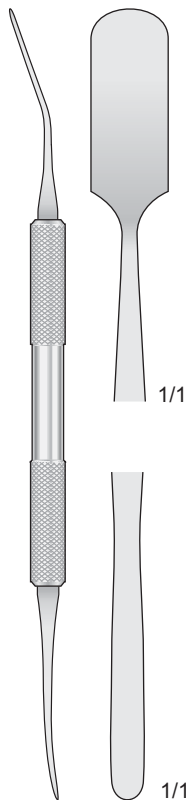

**PRICHARD
718-PR3**
175 mm



**BENNETT
KO-58**
175 mm

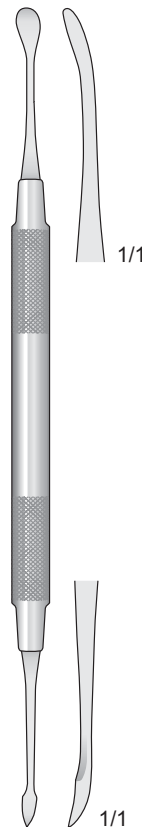

**MOLT
MO-8**
185 mm

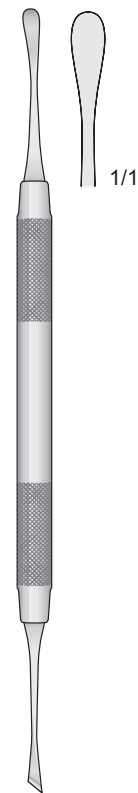

718-24G
175 mm

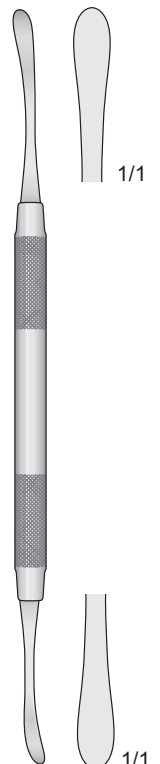

**GOLDMAN-FOX
718-GF14**
165 mm

Fig. 12S



Raspatorien

Periosteals

Scollaperiosteal

Periostotomos - Legras

Rugines à périostomie

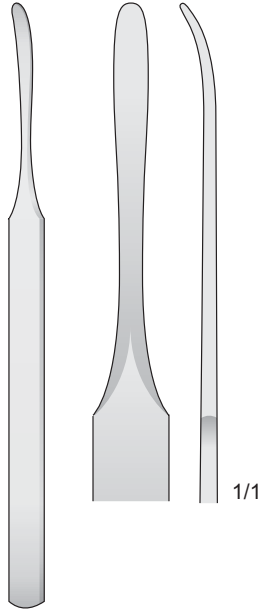

KÖNIG
KO-1
155 mm

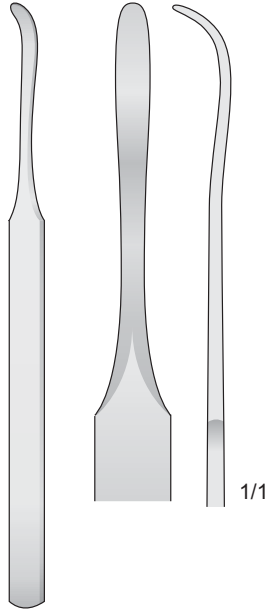

KÖNIG
KO-2
155 mm

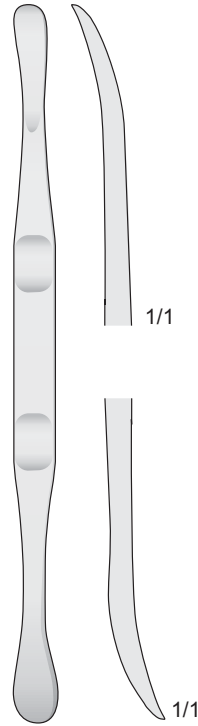

BABBUSH
KO-20
180 mm

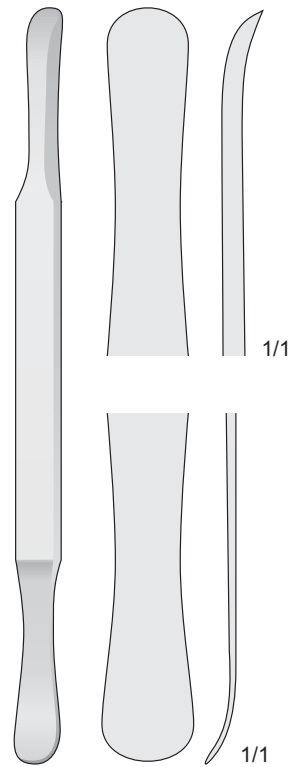

SELDIN
KO-23
195 mm

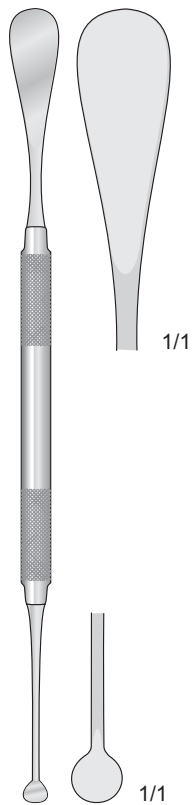

MO-20
200 mm

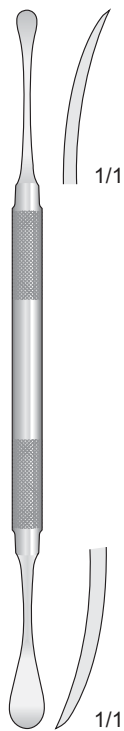

MENEGHINI
MO-24
180 mm

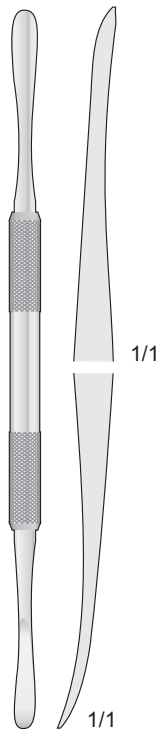

718-M8
185 mm

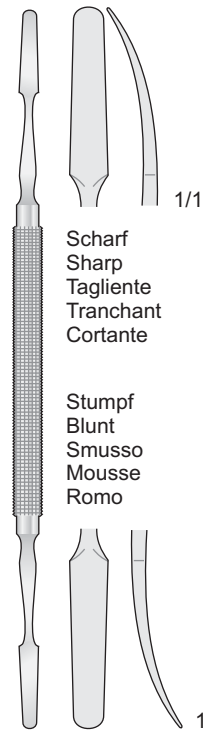

KILIAN
KO-11
180 mm

Scharf
Sharp
Tagliente
Tranchant
Cortante

Stumpf
Blunt
Smusso
Mousse
Romo

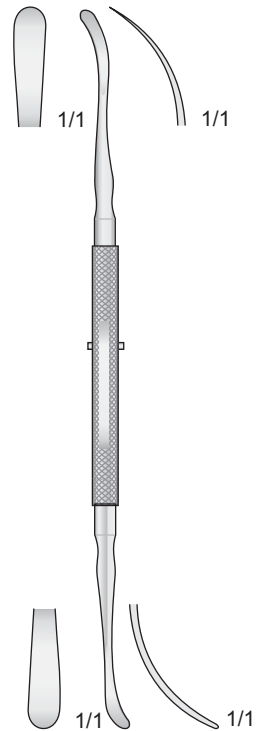

ROGER
KO-66
180 mm

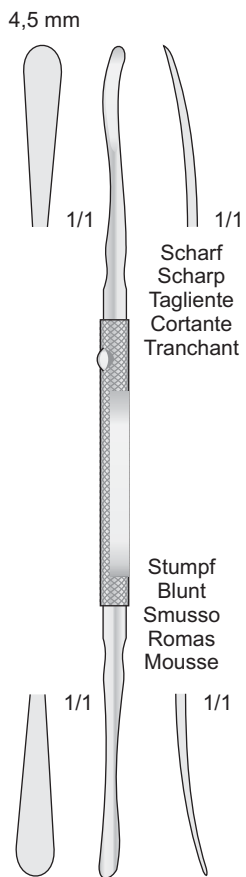

FREER
180 mm

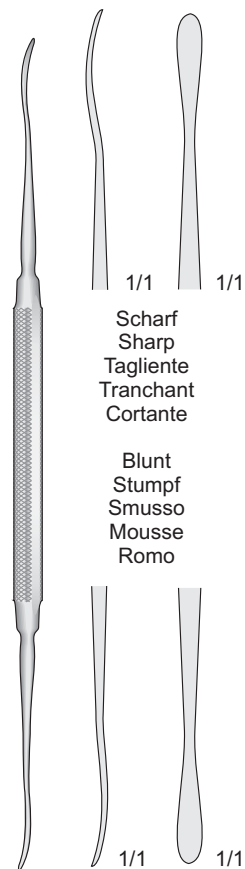

FREER
FR-16
185 mm

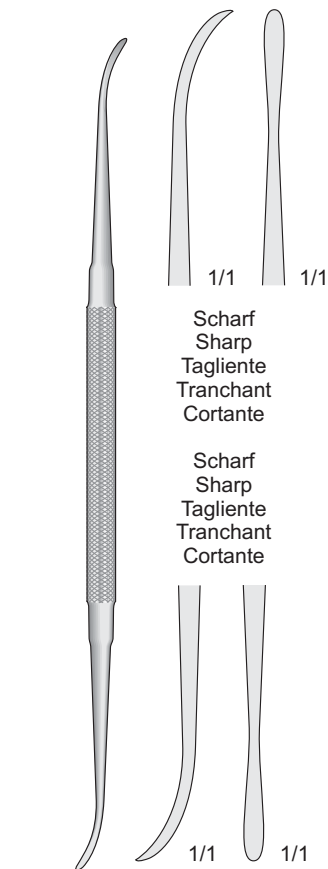

FREER-YASARGIL
FR-17
185 mm

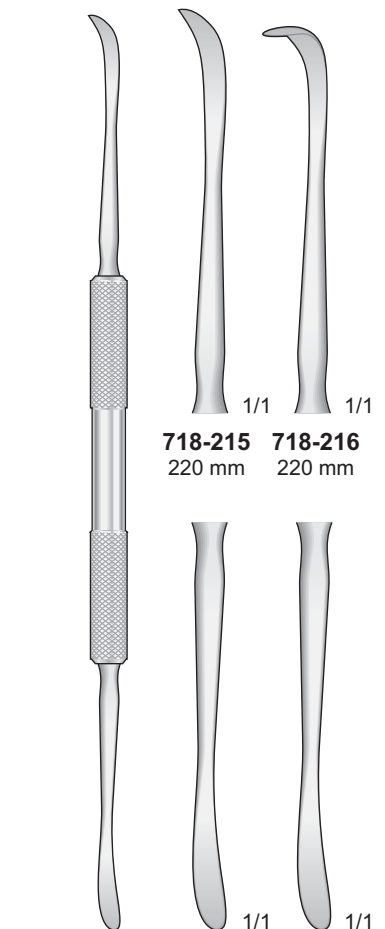

FREER
718-215/718-216
220 mm



**Elevatori
Raspatorien**

**Elevators
Periosteals**

**Elevatori
Scollaperiosteai**

**Elevador
Periostotomos**

**Élévateurs
Rugines à périostomie**

6,0 mm

10,0 mm

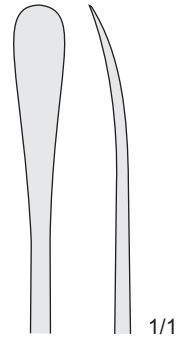

1/1

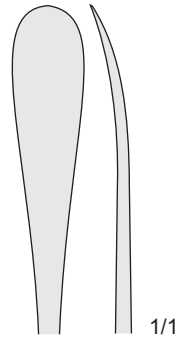

1/1

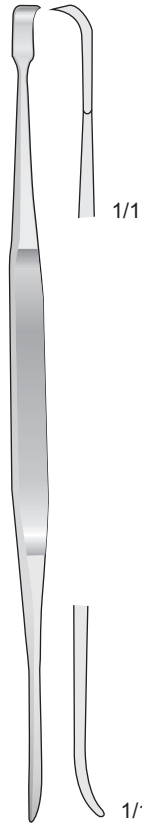

1/1

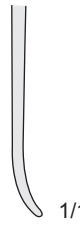

1/1

4 mm

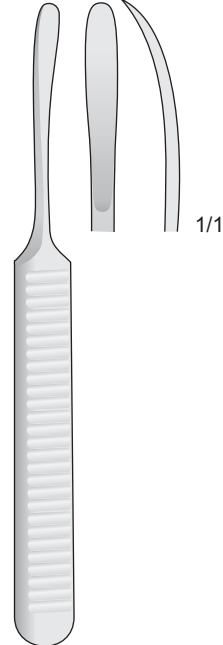

1/1

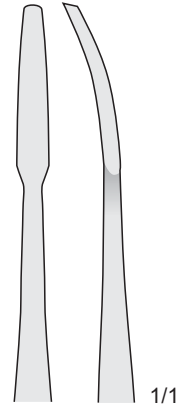

1/1

**HURD
BT-1/BT-2**
220 mm

12 mm

12 mm

**HOWARTH
KO-30**
210 mm

**WILLIGER
WG-14**
140 mm

**JOSEPH
FK-80**
170 mm

6 mm

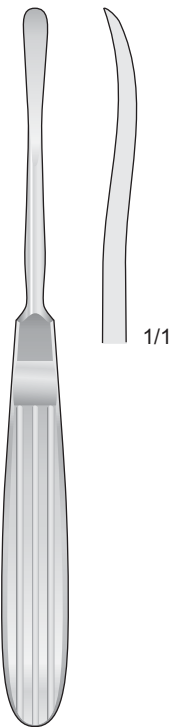

1/1

7 mm

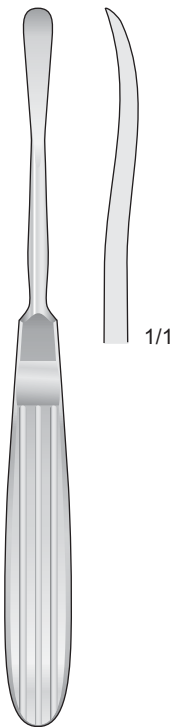

1/1

9 mm

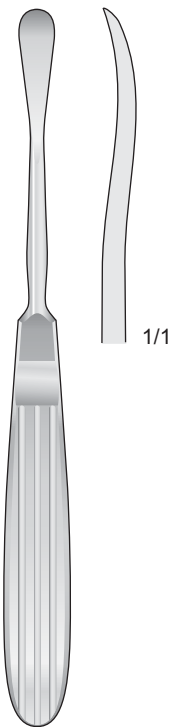

1/1

11 mm

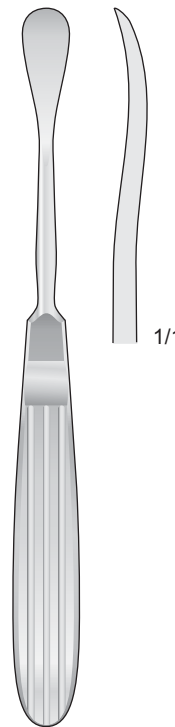

1/1

10 mm



**OBWEGESER
DO-59**
175 mm

**OBWEGESER
DO-63**
175 mm

**OBWEGESER
DO-67**
175 mm

**OBWEGESER
DO-65**
175 mm

**MOLT
MO-15**
160 mm



Scharfe Löffel

Sharp curettes

Curette, Cucchiai taglienti

Cucharillas cortantes

Curettes tranchantes

4,5 mm

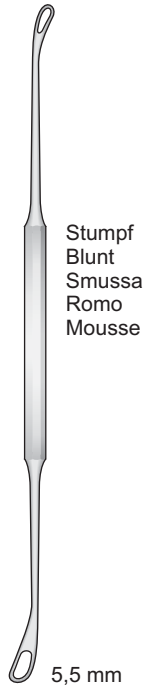

Stumpf
Blunt
Smussa
Romo
Mousse

5,5 mm

COXETER
DB-52
150 mm

1,0 mm/1,2 mm



Leicht Gebogen
Slightly angled
Leggermente
angolata
Ligeramente
acodadas
Légèrement
coudées

HOUSE
FR-160
150 mm

1,0 mm/1,2 mm



Stark Gebogen
Strongly angled
Fortemente
angolata
Fuertemente
acodadas
Fortement
coudées

HOUSE
FR-162
150 mm

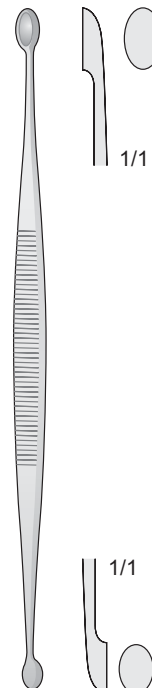

JACOBSON
FK-75
140 mm

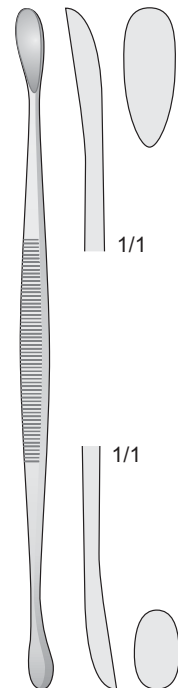

VOLKMANN
FK-72
145 mm

Surgical Curette



LUCAS
720-85/720-87
180 mm



720-85
180 mm



720-86
180 mm



720-87
180 mm



720-88
180 mm

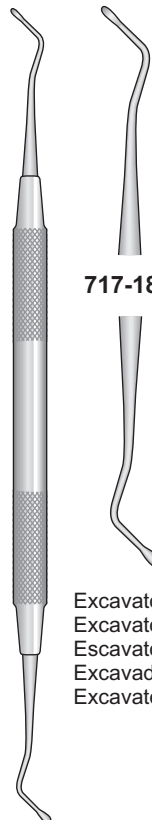

717-18W

Excavator
Excavator
Escavatore
Excavadore
Excavateurs

717-18W



Universal Kürette
Universal Curette
Curette universale
Cureta universale
Curette universelle

Stumpf
Blunt
Smussa
Romas
Mousse

718-M23A
165 mm



Sinus Lift Instrumente - Sinus Lift Instruments
Strumenti per rialzo del seno - Instrumentos para elevación de senos
Instruments pour les soulevés de sinus

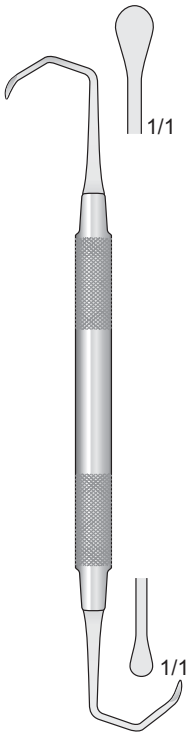

EN-M1
160 mm



EN-M2
160 mm



EN-M3
180 mm

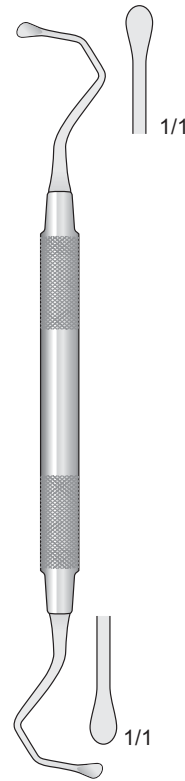

EN-M4
170 mm

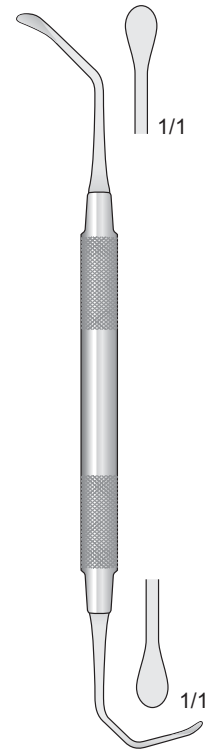

EN-M5
175 mm

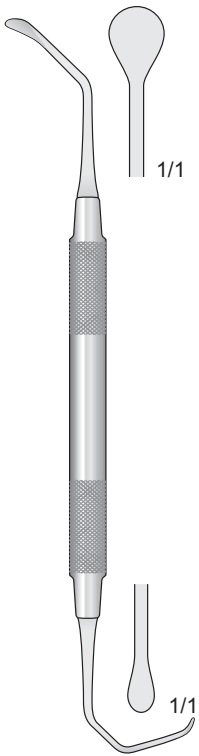

EN-M6
175 mm

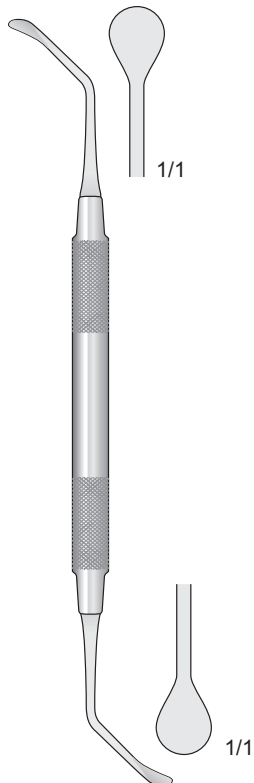

EN-M7
180 mm

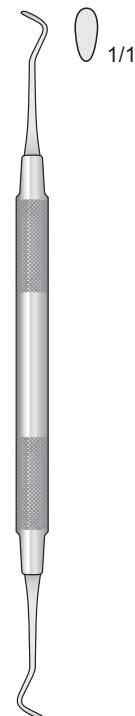

718-EN1
175 mm

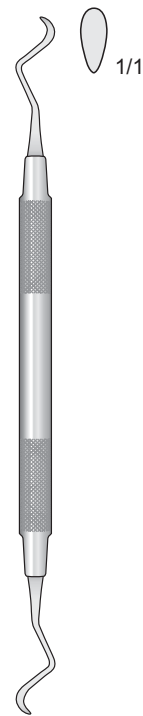

718-EN2
165 mm



718-EN3
170 mm



Sinus Lift Instrumente
 Sinus Lift Instruments
 Strumenti per rialzo del seno
 Instrumentos para elevación de seños
 Instruments pour les soulevés de sinus

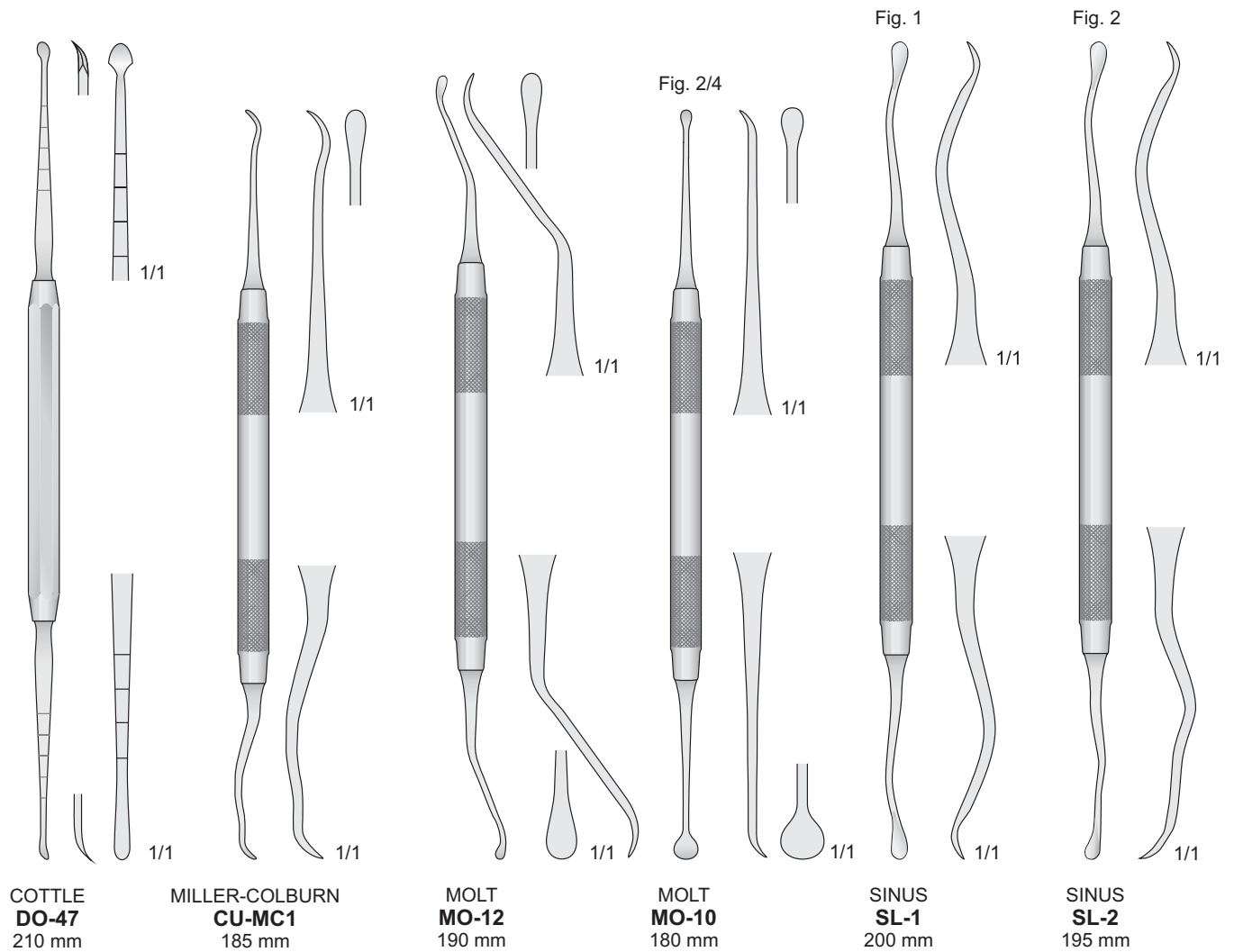



Knochen-Stopfer
Scharfe Löffel

Bone Compactor
Scharp curettes

Compattatori per osso
Cucchiaini taglienti

Compactador de huesos
Cucharillas cortantes

Compactateur des os
Curettes tranchantes

Knochenmateriallöffel
Bone scoops
Cucchiaini per osso
Cucharillas para huesos
Curettes à os

Knochenstopfer
Bone tampers - Bone packers
Compattatore per osso
Compactador
Compacteur - Pilons

Knochenmaterialstopfer
Bone pluggers
Compattatore - Spatola
per osso
Condensadore óseos
Fouloirs à os

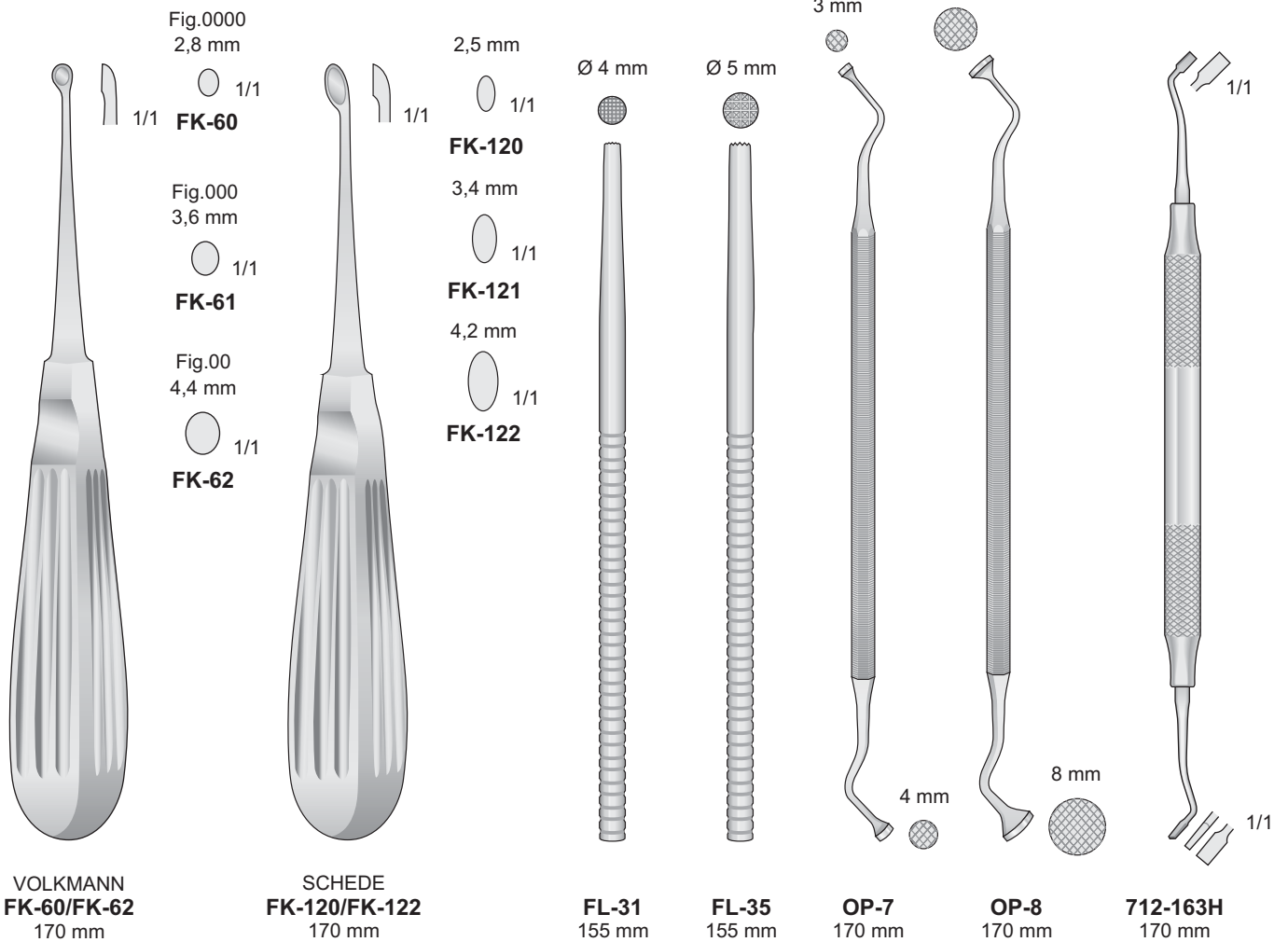



Osteotome

Osteotomes

Osteotomi

Ostéotomes

Osteòtoms

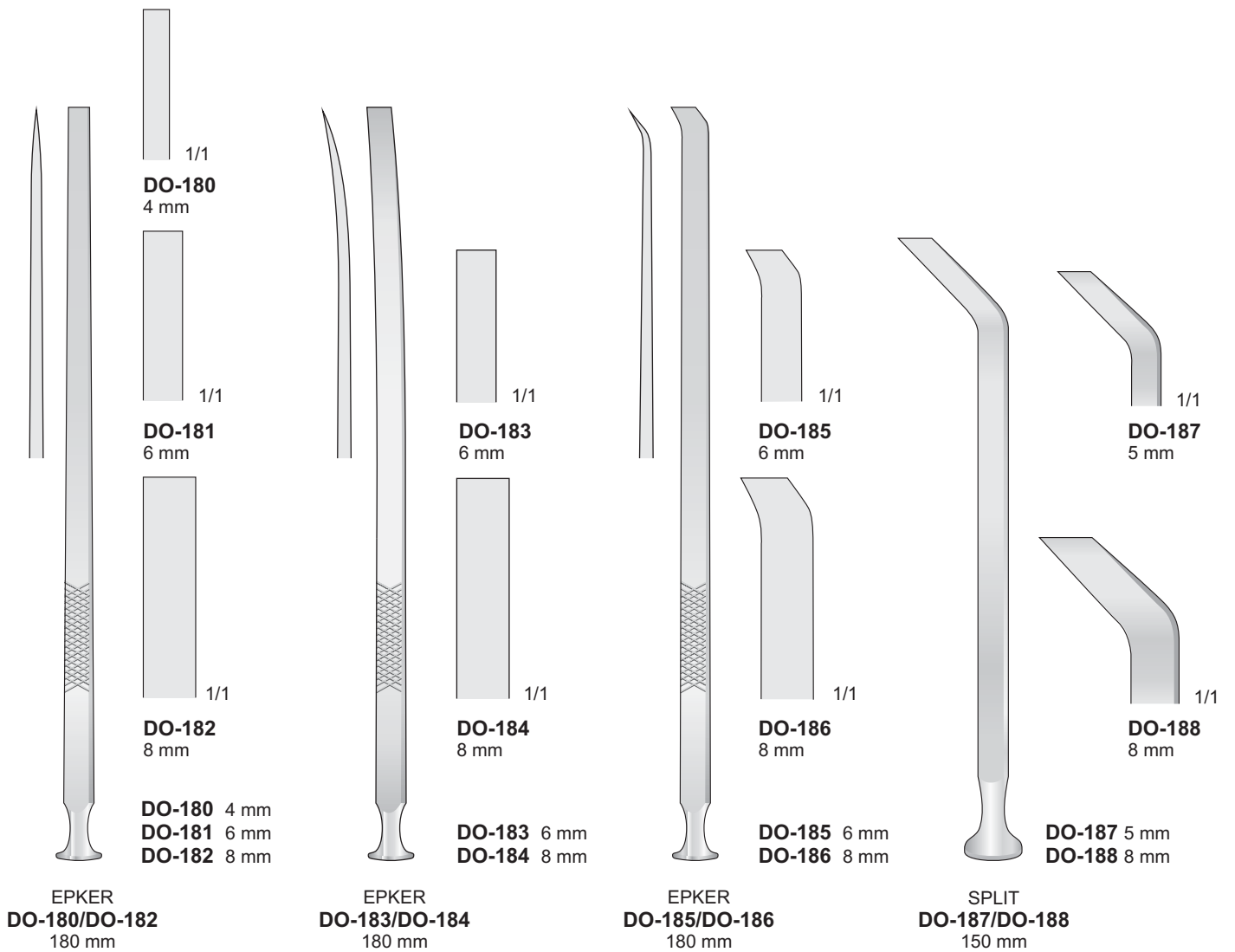



**Meissel
Osteotome**

**Chisels
Osteotomes**

**Scalpelli
Osteotomi**

**Cinceles
Osteótomos**

**Scalpel
Ostéotomes**

Fig. 4



**OCHSENBEIN
OSB/4A**
170 mm

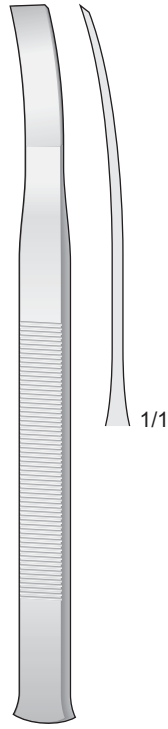

**TESSIER
FL-404** 10 mm
160 mm

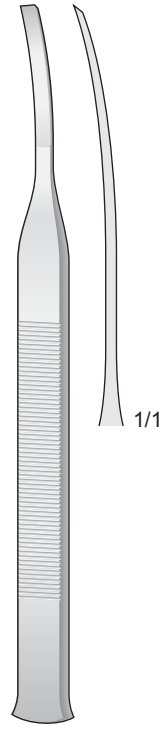

**TESSIER
FL-411** 5 mm
FL-412 7 mm
160 mm

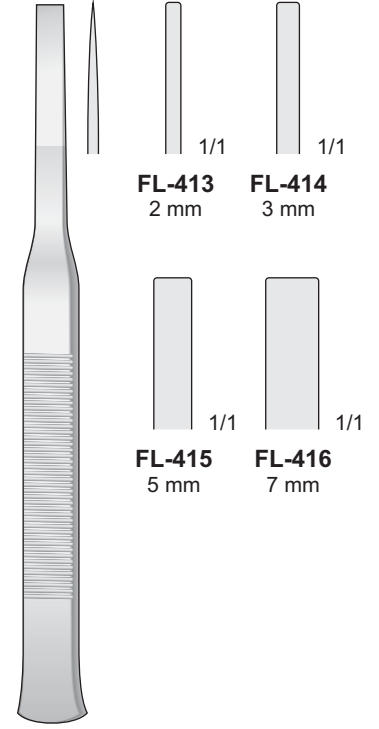

**TESSIER
FL-413/FL-416**
160 mm

FL-413
2 mm

FL-414
3 mm

FL-415
5 mm

FL-416
7 mm

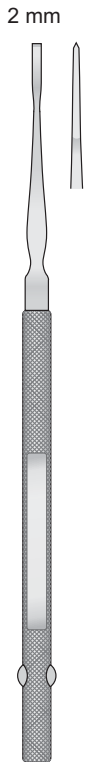

**FREER
TG-20**
160 mm

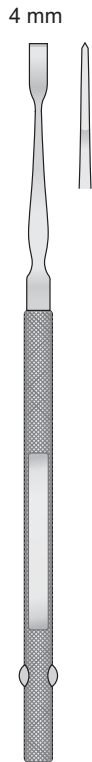

**FREER
TG-21**
160 mm

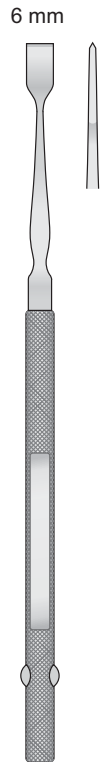

**FREER
TG-22**
160 mm

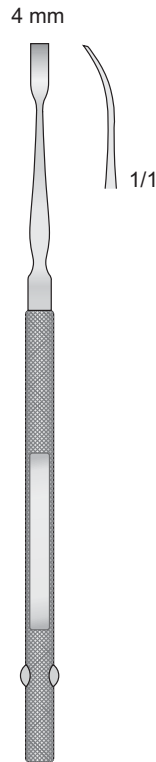

**FREER
TG-23**
160 mm

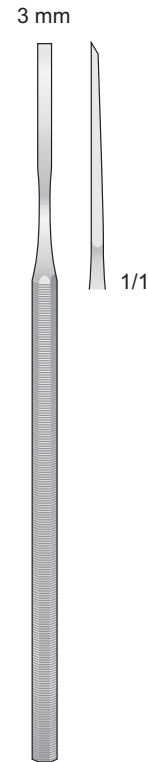

TG-30
155 mm

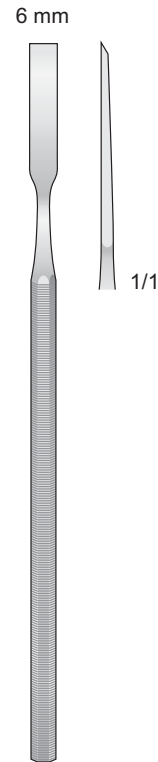

TG-31
155 mm

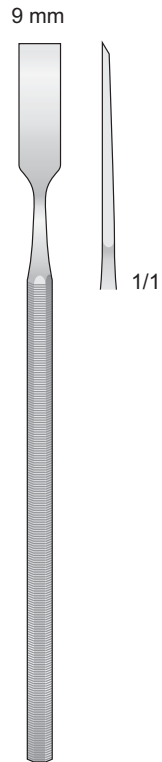

TG-32
155 mm

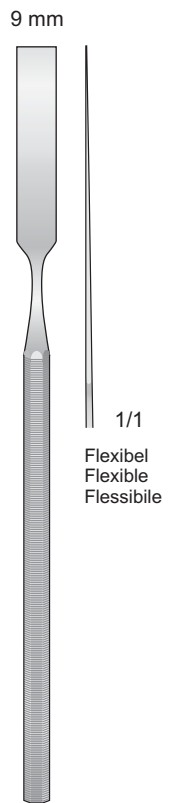

TG-15
170 mm



Mit auswechselbaren Kunststoffbacken
 With interchangeable plastic disks
 Con punte e ricambi in teflon
 Con tapas de plástico reemplazables
 Avec embouts de plastique rechargeables

Ø 20 mm
160 g

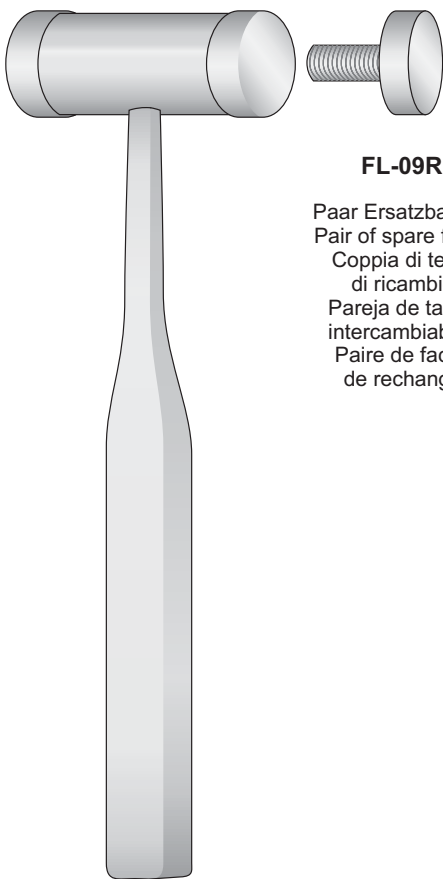

FL-09R

Paar Ersatzbacken
 Pair of spare faces
 Coppia di teste
 di ricambio
 Pareja de tapas
 intercambiables
 Paire de faces
 de rechange

FL-09
190 mm

Ø 25 mm
200 g

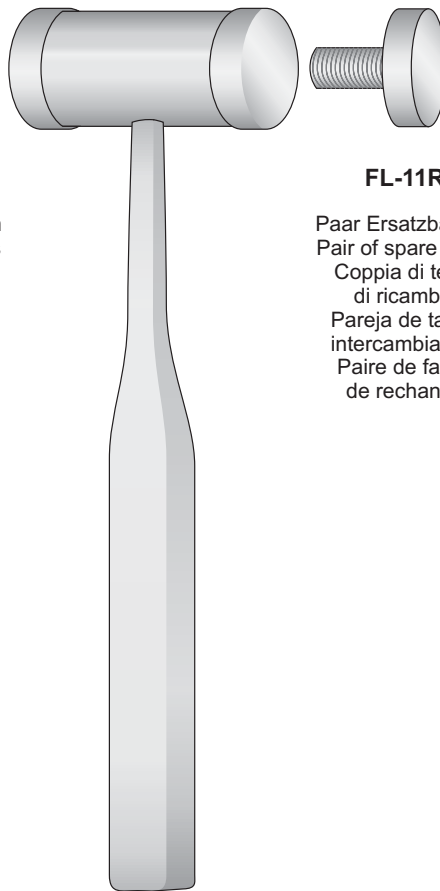

FL-11R

Paar Ersatzbacken
 Pair of spare faces
 Coppia di teste
 di ricambio
 Pareja de tapas
 intercambiables
 Paire de faces
 de rechange

FL-11
200 mm

Ø 26 mm
320 g

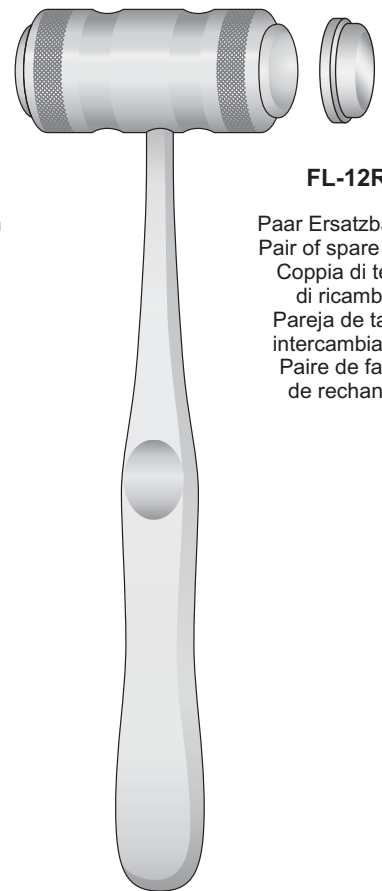

FL-12R

Paar Ersatzbacken
 Pair of spare faces
 Coppia di teste
 di ricambio
 Pareja de tapas
 intercambiables
 Paire de faces
 de rechange

MEAD
FL-12
190 mm



Osteotome

Osteotomes

Osteotomi

Osteòtoms

Ostéotomes

Knochenmeißel Graduiert
Graduated Chisels
Scalpelli graduati
Osteótomos graduado
Ostéotomes gradués

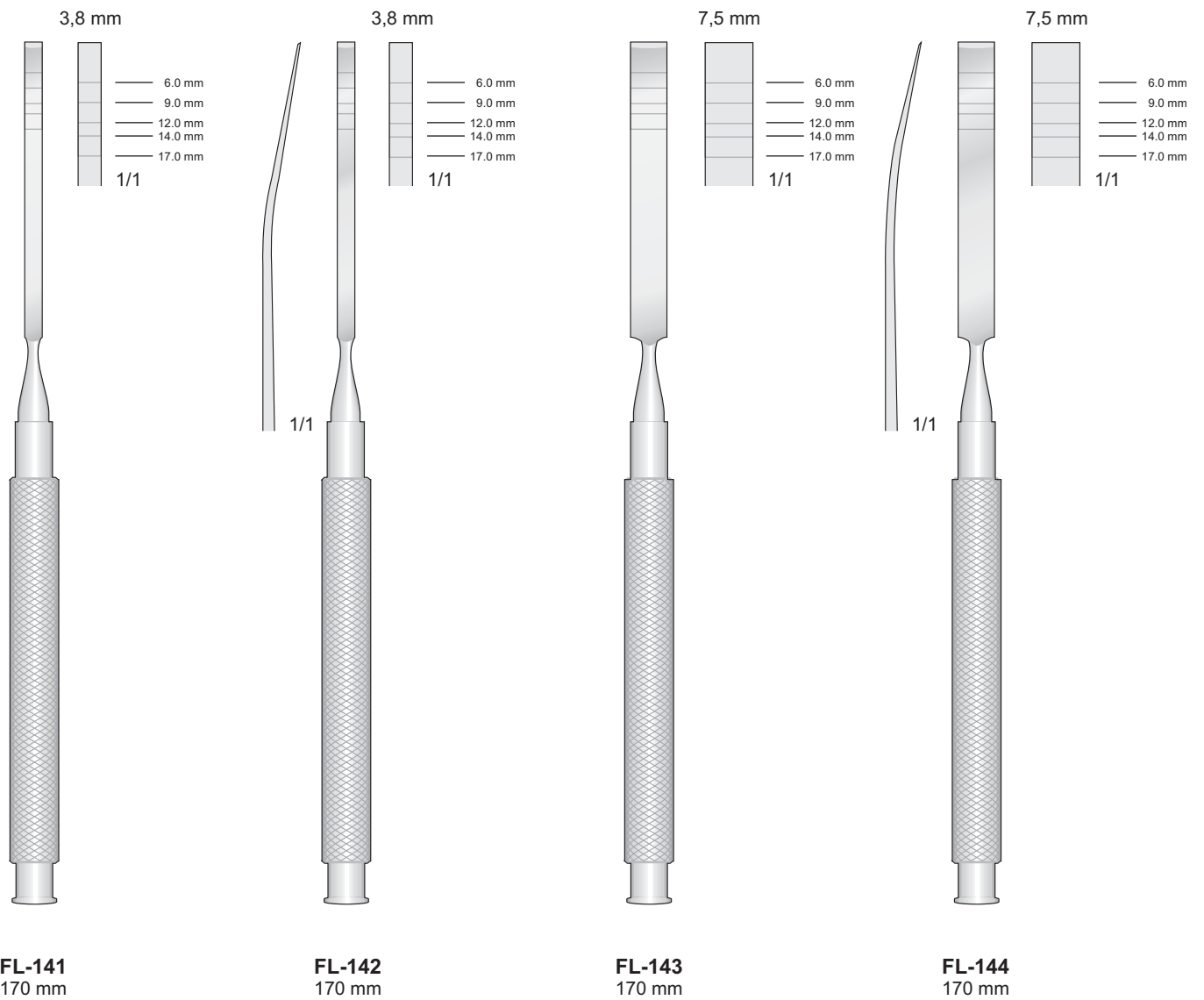



Implant Sinus Lift Osteotomes

FL-400
Komplettset mit
Set complete with
Set completo con
Kit completo con
Set complete avec
BS-60
FL-391/FL-399
(Fig.1 - 2 - 3 - 4 - 5 - 6 - 7 - 8 - 9)

Fig. 1
Ø 2.5 mm



FL-391
155 mm

Fig. 2
Ø 2.5 mm



FL-392
155 mm

Fig. 3
Ø 2.5 mm



FL-393
155 mm

Fig. 4
Ø 2.5 mm

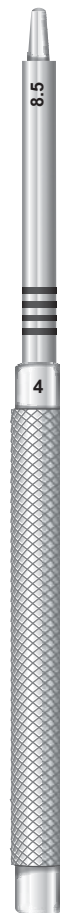

FL-394
155 mm

Fig. 5
Ø 2.5 mm



FL-395
155 mm



Implant Sinus Lift Osteotomes

FL-400M

Komplettset mit
 Set complete with
 Set completo con
 Kit completo con
 Set complete avec

BS-60
FL-389/FL-399
 (Fig.00 - 0 - 1 - 2 - 3 - 4 - 5 - 6 - 7 - 8 - 9)

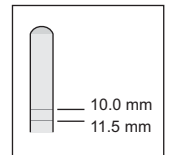
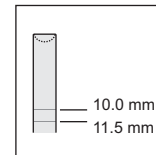

Fig. 6
Ø 2.5 mm



FL-396
155 mm

Fig. 7
Ø 2.5 mm



FL-397
155 mm

Fig. 8
Ø 2.5 mm



FL-398
155 mm

Fig. 9
Ø 2.5 mm



FL-399
155 mm

Fig. 00
Ø 3.0 mm

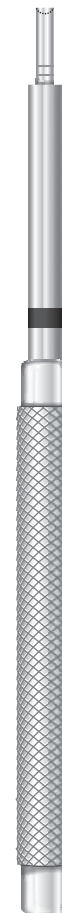

FL-389
155 mm

Fig. 0
Ø 3.0 mm



FL-390
155 mm



Fig. 1		Fig. 2		Fig. 3		Fig. 4		Fig. 5		Fig. 6	
Altezza	Diametro	Altezza	Diametro	Altezza	Diametro	Altezza	Diametro	Altezza	Diametro	Altezza	Diametro
0	Ø 1,60	0	Ø 1,90	0	Ø 2,80	0	Ø 3,10	0	Ø 3,90	0	Ø 5,50
7,5	Ø 1,80	7,5	Ø 2,20	7,5	Ø 3,20	7,5	Ø 3,70	10	Ø 5	10	Ø 6,20
10	Ø 2	10	Ø 2,35	10,5	Ø 3,35	10,5	Ø 3,90	13	Ø 5,20	13	Ø 6,30
13,5	Ø 2,40	13,5	Ø 3,30	13,5	Ø 3,60	15,5	Ø 4,30	20,5	Ø 6,30		
15,5	Ø 3,60	15,5	Ø 3,40	21	Ø 4,40						
		23,5	Ø 4,50								

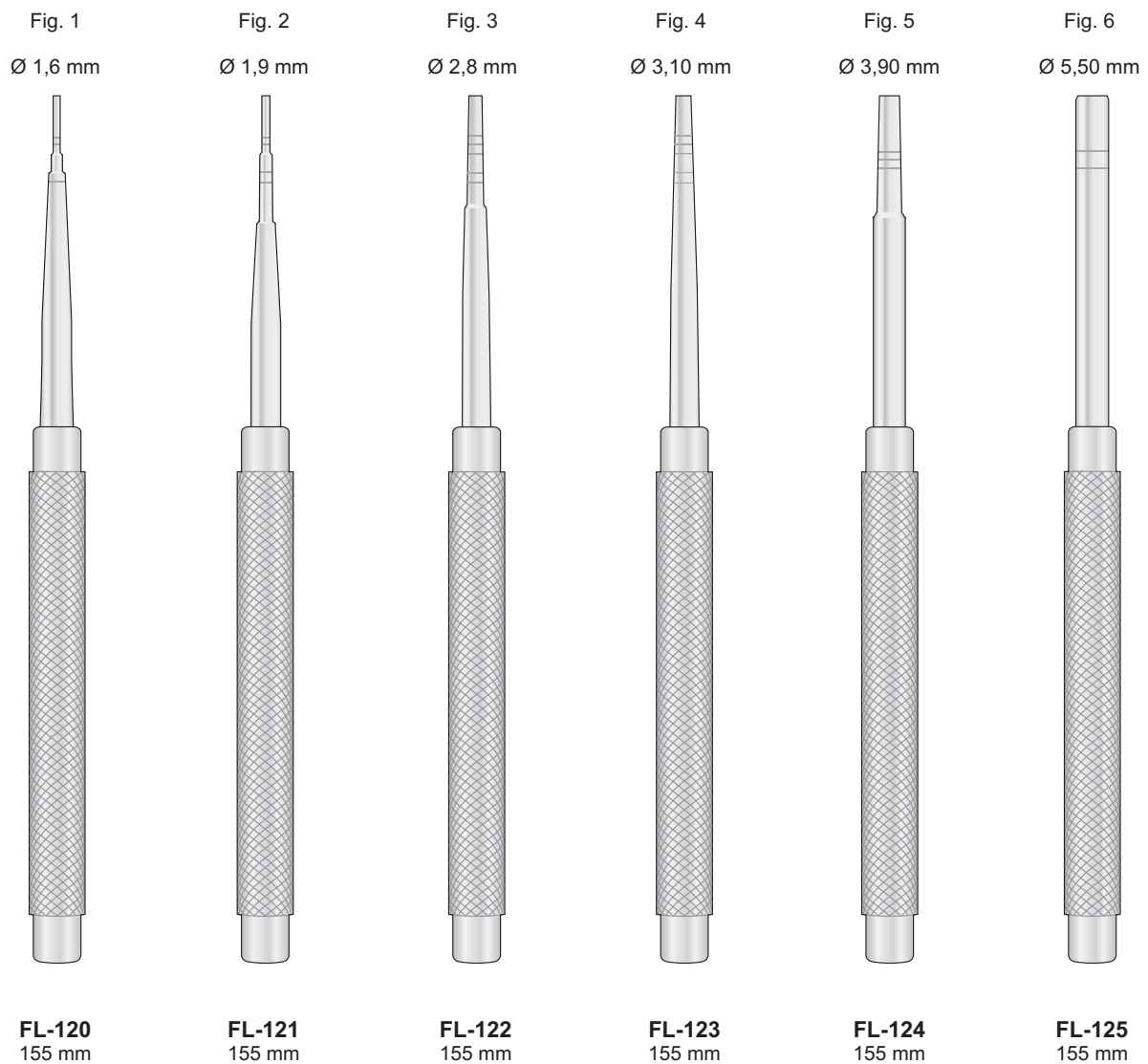



Osteotome

Osteotomes

Osteotomi

Osteòtomos

Ostéotomes

L.	Ø 1° osteotomo	Ø 2° osteotomo	Ø 3° osteotomo	Ø 4° osteotomo	Ø 5° osteotomo
0	1,5	2,1	2,6	3,0	3,5
5	1,9	2,6	3,0	3,5	3,9
8	2,2	2,8	3,3	3,8	4,2
10	2,4	3,0	3,5	4,0	4,4
12	2,6	3,2	3,7	4,2	4,6
14	2,8	3,4	3,9	4,4	4,8

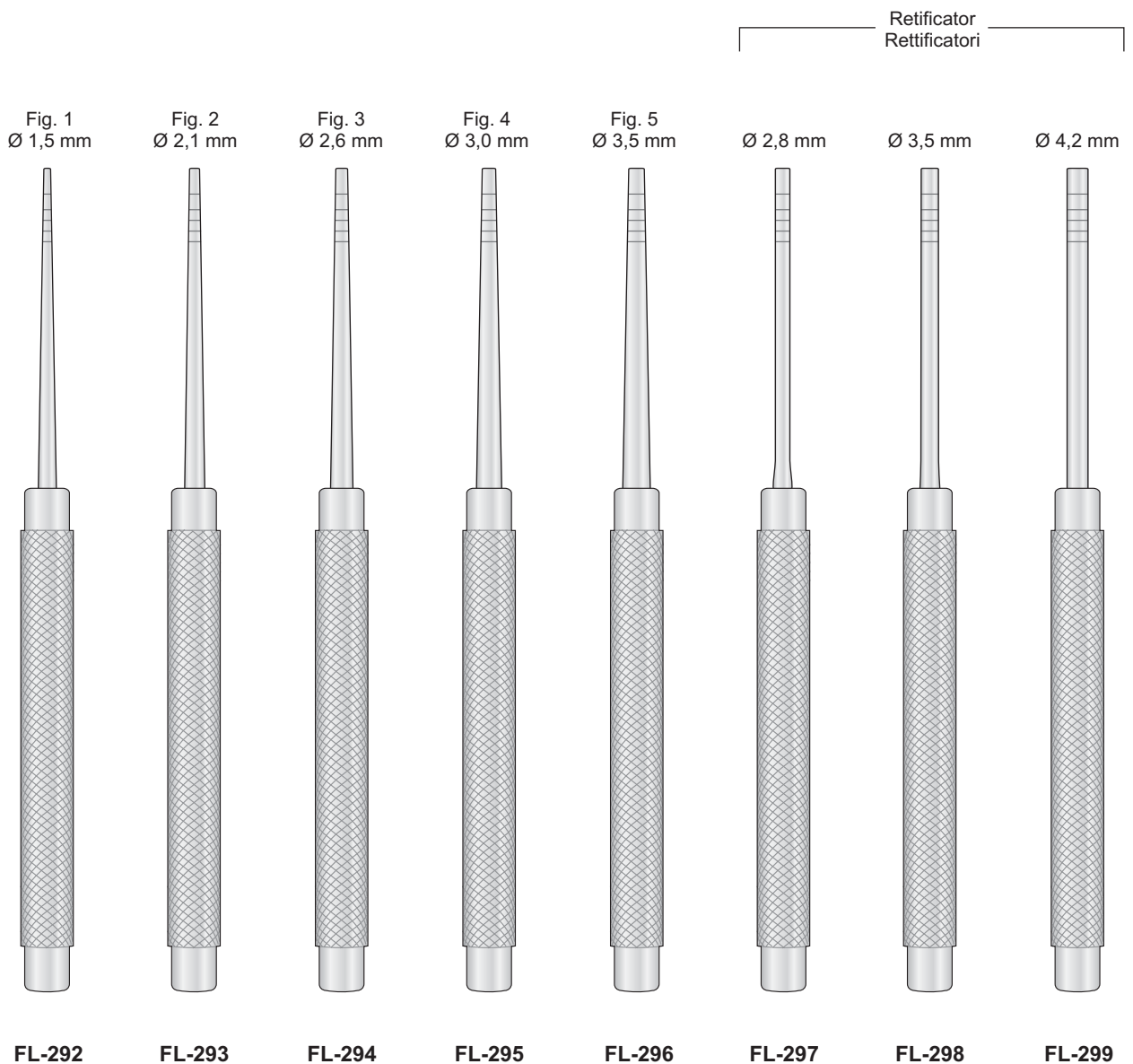



Osteotome

Osteotomes

Osteotomi

Osteòtomos

Ostéotomes

Osteotome konkav mit Stop - Osteotomes concave with Stop
 Osteotomi concavi con Stop - Ostéotomos cóncavo con Stop
 Ostéotomes concaves avec Stop

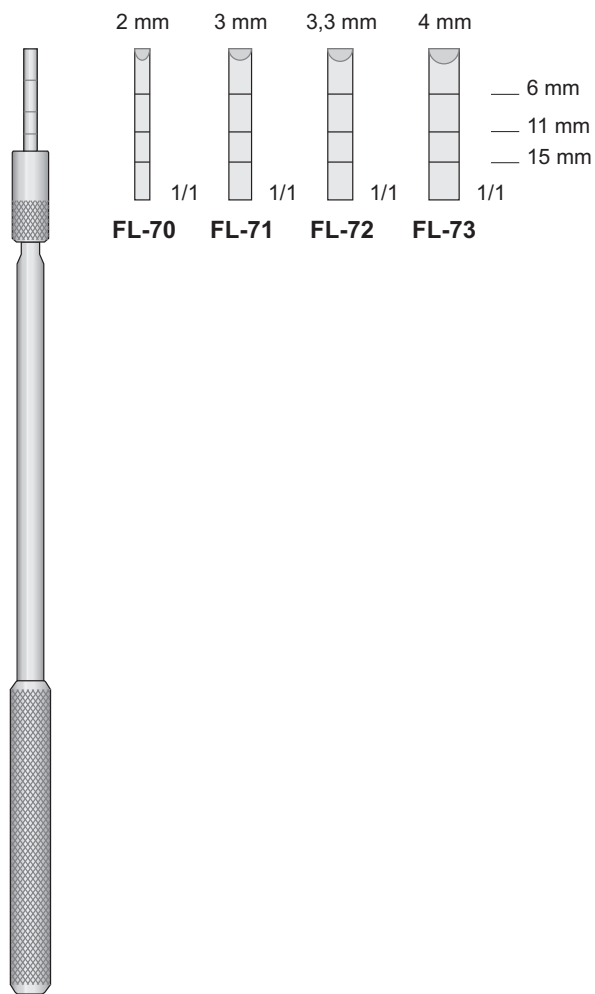

FL-70/FL-73
165 mm

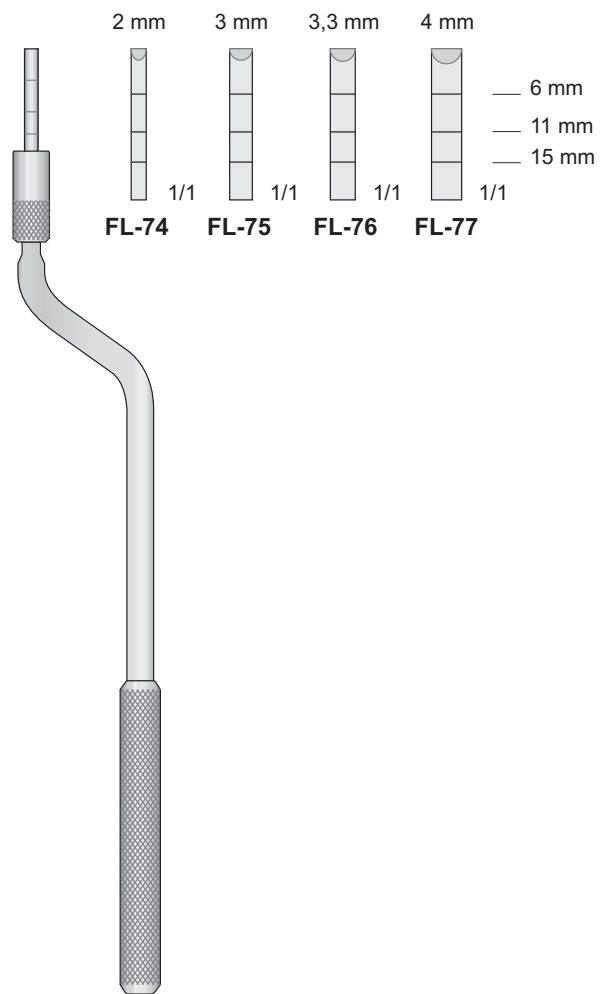

FL-74/FL-77
165 mm



Osteotome konvex mit Stop - Osteotomes convex with Stop
Osteotomi convessi con Stop - Ostéotomos convexe con Stop
Ostéotomes convexes avec Stop

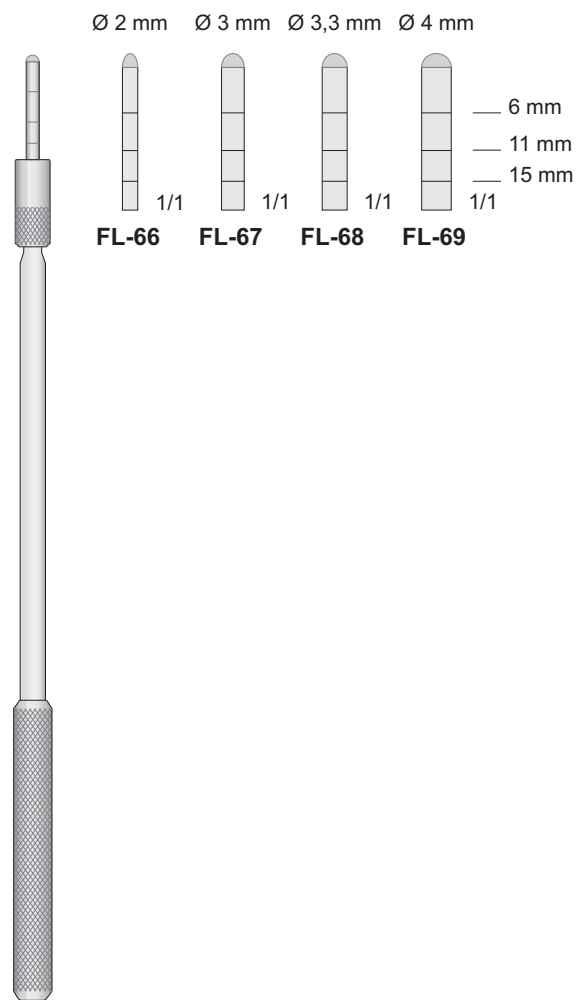

FL-66/FL-69
165 mm

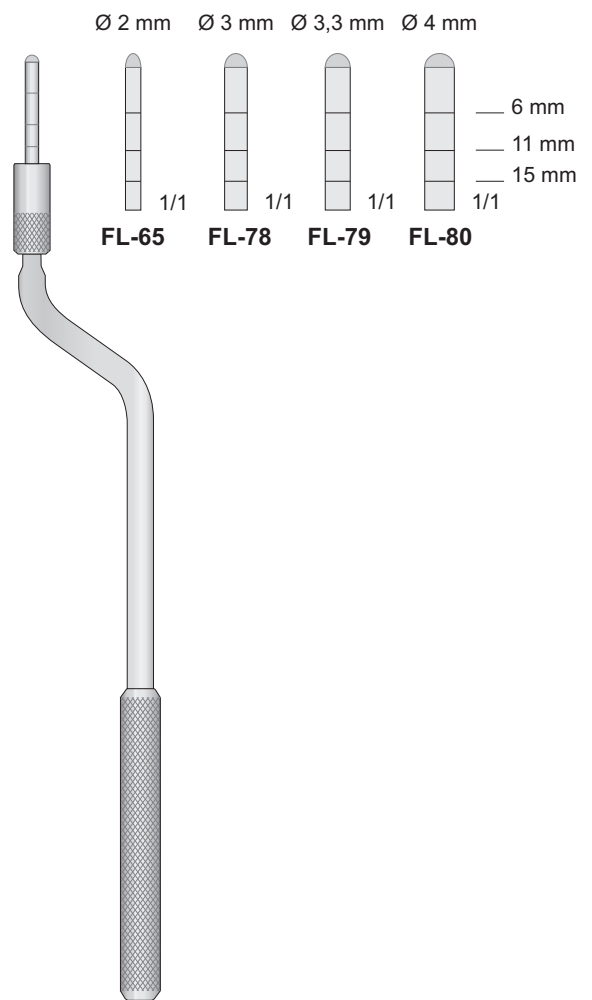

FL-65/FL-80
160 mm



Osteotome

Osteotomes

Osteotomi

Osteótomos

Ostèotomes

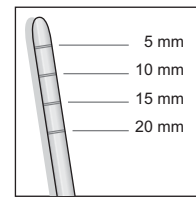
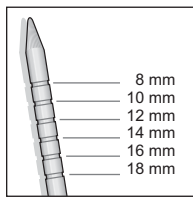

Implant Site Dilator
Implant Site Dilators
Dilatatori per osso
Dilatadores oséos
Dilatateur d'os

Expansion Osteotome
Expansion Osteotomes
Espansori di osso
Expansores oséos
Expanseurs d'os

Ø 2 mm

Ø 3 mm

Ø 3,3 mm

Ø 4 mm

Ø 3 mm

Ø 4 mm

Ø 5 mm



FL-25
145 mm

FL-26
145 mm

FL-27
145 mm

FL-28
145 mm

FL-37
145 mm

FL-38
145 mm

FL-39
145 mm



Dentalschaft
Dental Attack
Attacco Dental

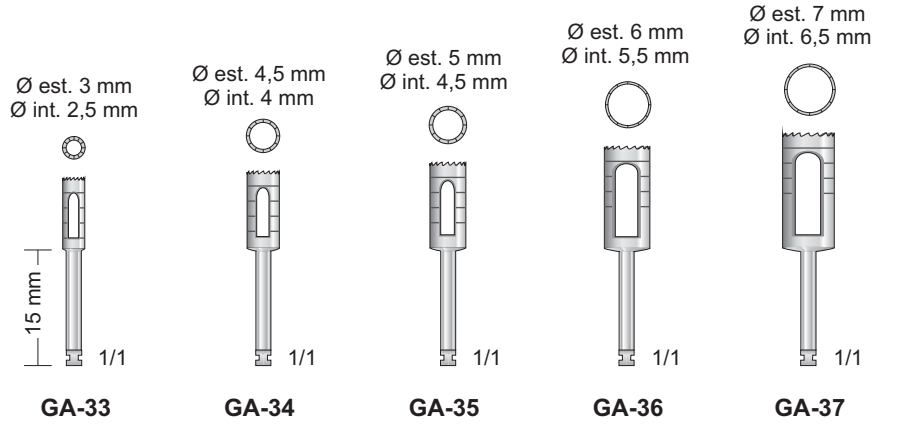

Zirkulirmesser - Circular knife
Mucotomi, Bisturi circolari - Cuchillo circular
Couteau circulaire

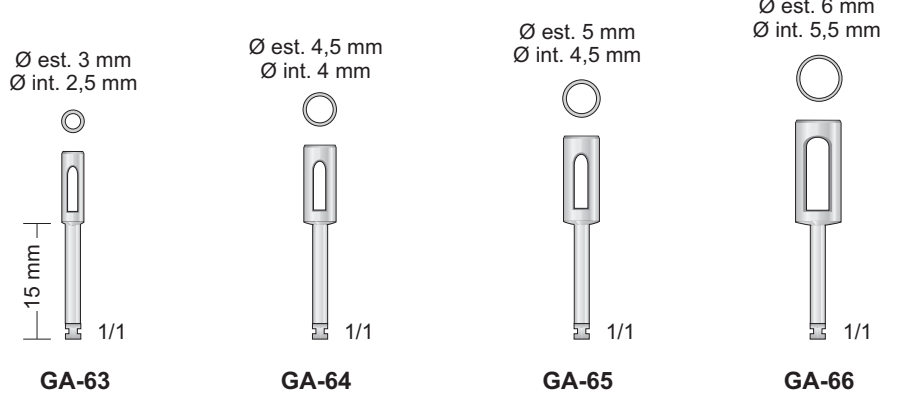

Hautstanzen - Tissue punches
Mucotomi Punches - Punches para cortar tejidos
Punches à couper le tissu

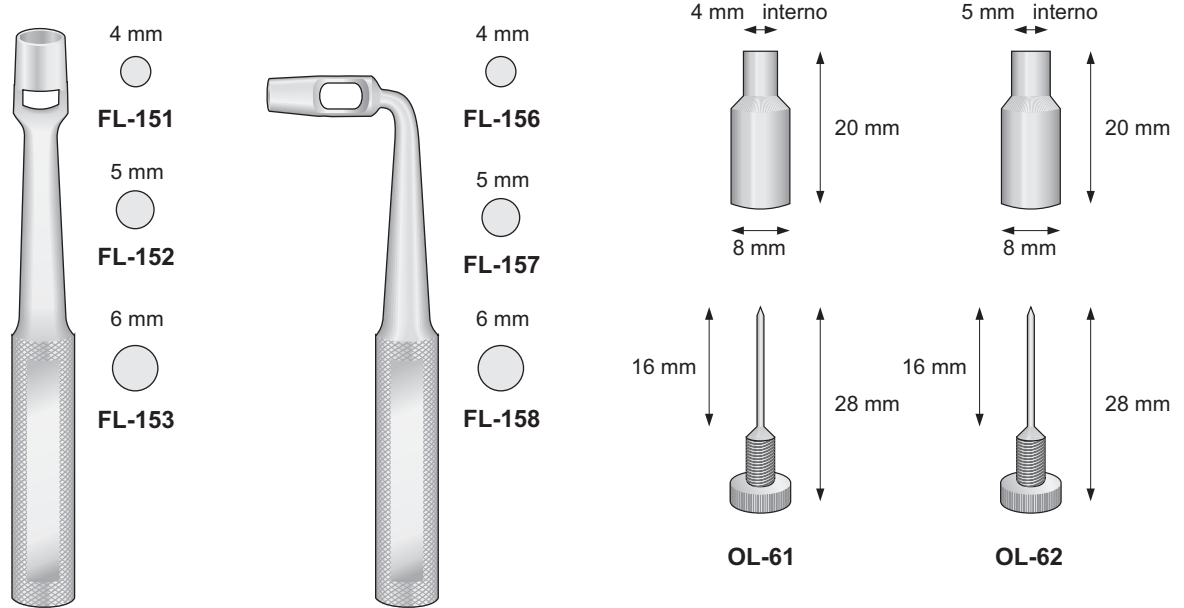

KEYES
FL-151/FL-153
100 mm

KEYES
FL-156/FL-158
90 mm



Knochenschale
Bone Well
Bacinella per osso
Cubeta para hueso
Cuvette à os



Rostfrei
Stainless Steel
Acciaio inossidabile
Acero inoxidable
Acier Inoxydable

SS-65
35 mm

Absaugkanülen für Knochen, mit 1 Filter
Suction tube for bone, with 1 filter
Cannule d'aspiration con trattenuta osso, con 1 filtro
Cánulas aspiradoras para hueso, con 1 filtro
Canule à aspiration d'os avec 1 filtre

Knochenfilter
Bone Filter
Filtro per osso
Filtro de hueso
Filtre d'os

Rostfrei
Stainless Steel
Acciaio inossidabile
Acero inoxidable
Acier Inoxydable

Ø 10 mm int.

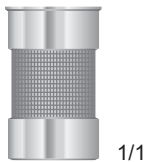

GF-134
20 mm

Sterilisierbar
Autoclavable
Autoclavabile

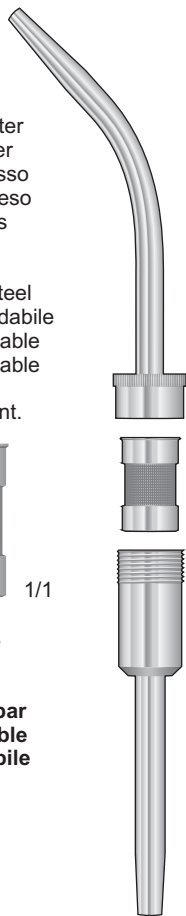

GF-133
180 mm

Membranplatzierungsinstrumente
Membrane Placement Instruments
Strumenti per posizionare membrana
Instrumentos para colocar membranas
Instruments d'application de membrane

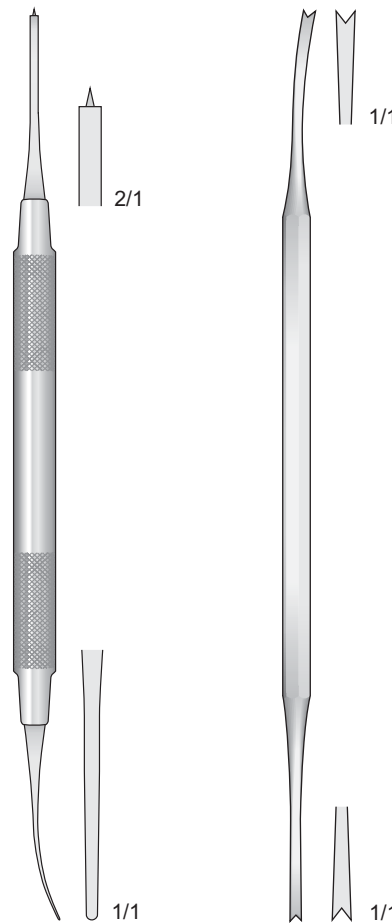

MPI-1
185 mm

LUNIATSCHEK
PF-6
170 mm

Aufbring Instrument
für Knochenmaterial
Applicator for bone material
Aplicatore per materiale osseo
Cucharillas para huesos
Curettes à os

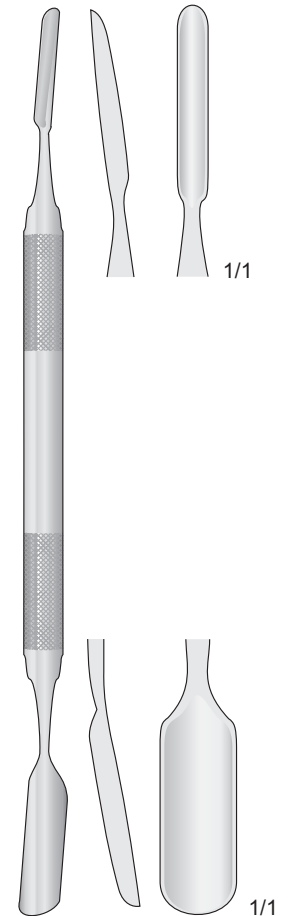

IM-15
180 mm



Knochenschaber
Rostfrei Stahl

Bone scraper
Stainless Steel

Grattini per osso
Inox

Raspador de hueso
Acero inoxidable

Râpes á os
Acier inoxydable

Multiple use, Replaceable blades
Ideale per il prelievo di osso autologo

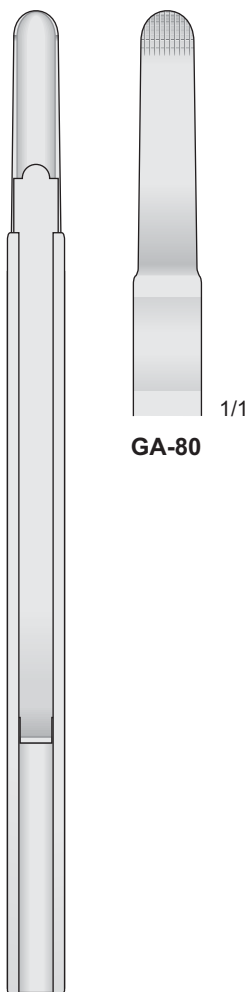

GA-80

GA-80
155 mm

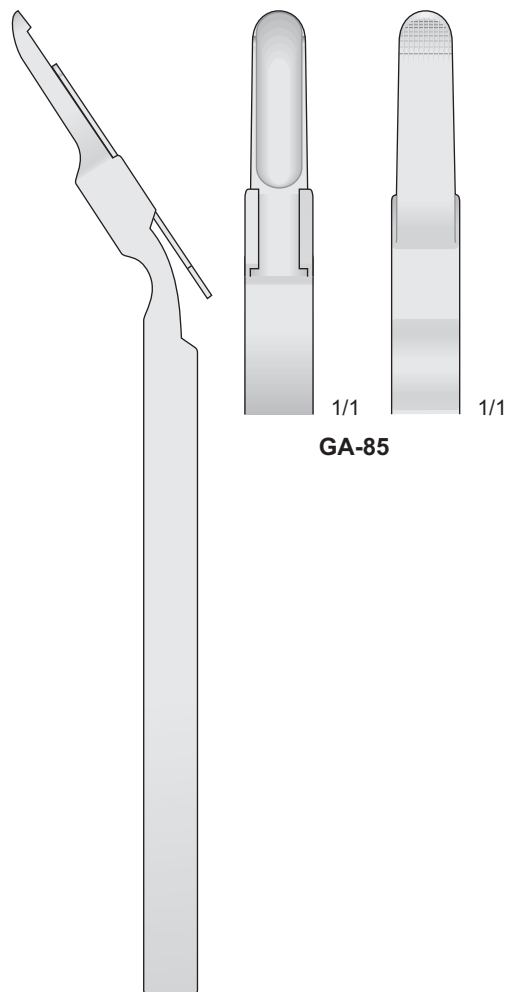

GA-85

GA-85
155 mm

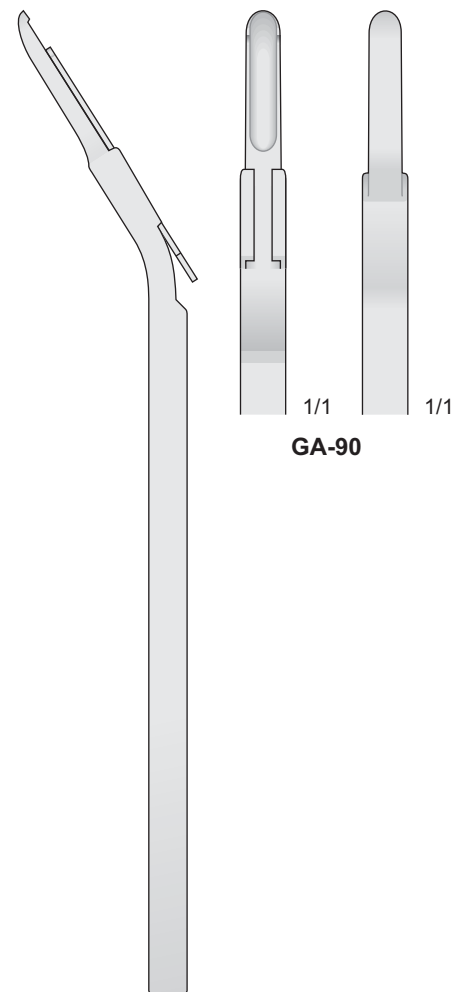

GA-90

GA-90
155 mm

**GA-95**

Abnehmbarer Griff
Handle
Manico ad innesto
Mango de innesto
Manche à greffe
195 mm

GA-96

Knochenbehälter
Container for bones
Vaschetta porta-osso con presa
Caja porta hueso
Réceptade d'os

GA-97

Oberer Knochendrücker
Presse bone superior
Tassello spingi-osso superiore
Enchufe para los huesos
Poussoir d'os supérieur

GA-98

Gips Reibe Fein #1
Plaster Rasp Fine #1
Grattugia per CIPS fine #1
Cilindro de corte fino #1
Ràpe pour chips fin #1

GA-99

Gips Reibe Groß #2
Plaster Rasp Large #2
Grattugia per CIPS grossi #2
Cilindro de corte grande #2
Ràpe pour chips large #2

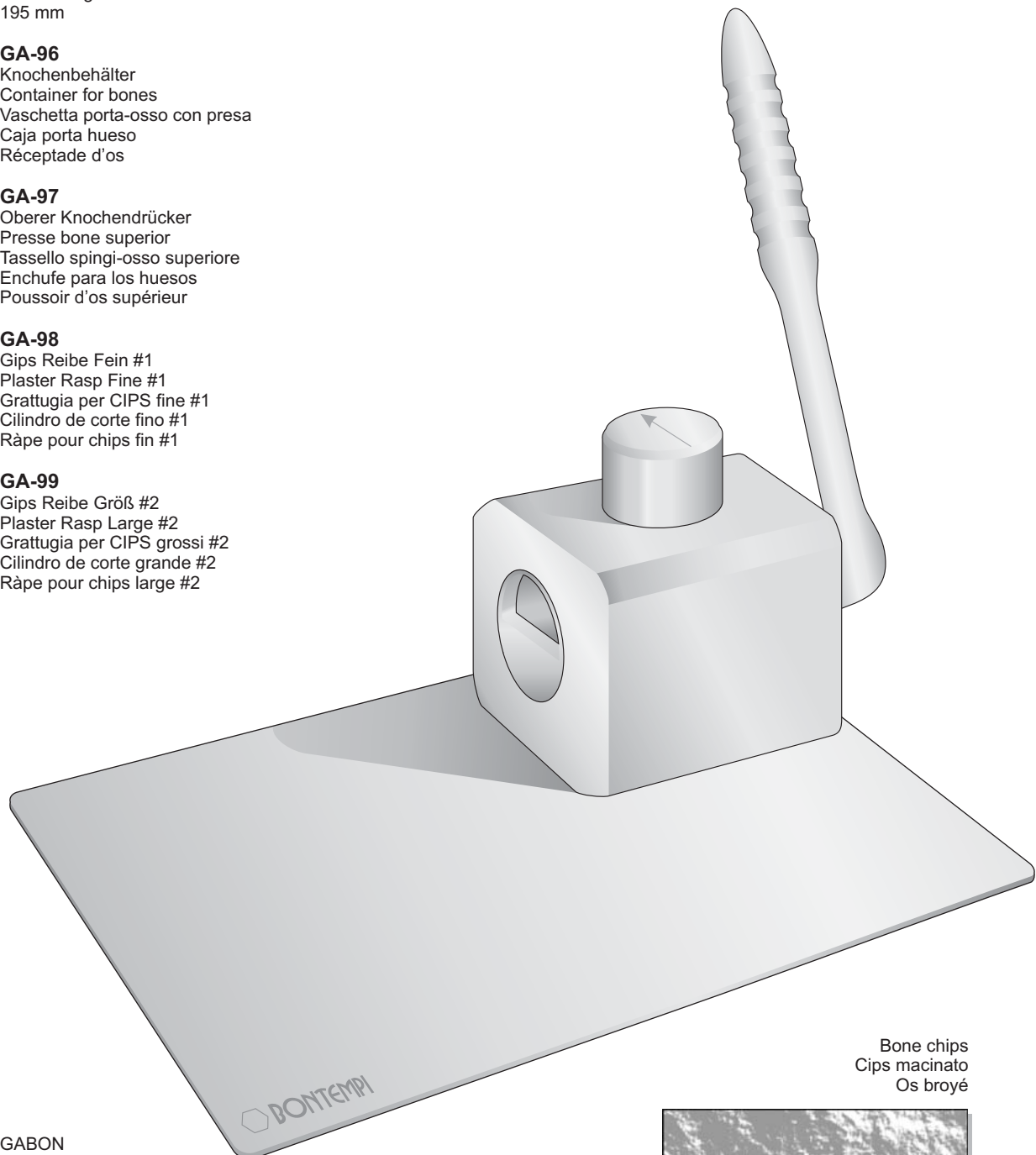

Bone chips
Cips macinato
Os broyé

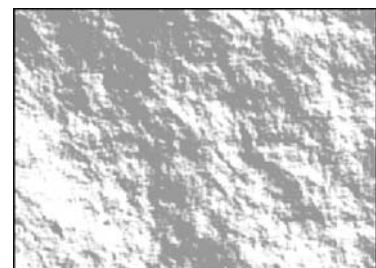

GABON

GA-100

235 x 160 x 100 mm
Kg 4,5

Nur mit 1 Gips Reibe
Only with 1 Plaster Rasp
Comprende una sola grattugia
Con 1 cilindro de corte
Avec 1 cylindre de coupe



Einbringinstrument f3r Knochenmaterial
Graft materials Syringes
Inserters for Bone material
Siringhe per biomateriali

Knochenspritzen
Bone Syringes
Siringhe per osso
Jeringas de hueso
Seringues 3 os

Ø Int. 2,5 mm
Ø Est. 3,5 mm

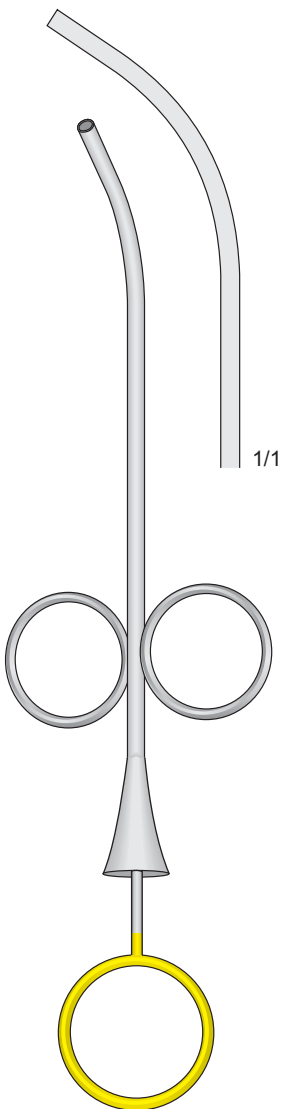

SS-60M
160 mm

Ø Int. 3,5 mm
Ø Est. 4,5 mm

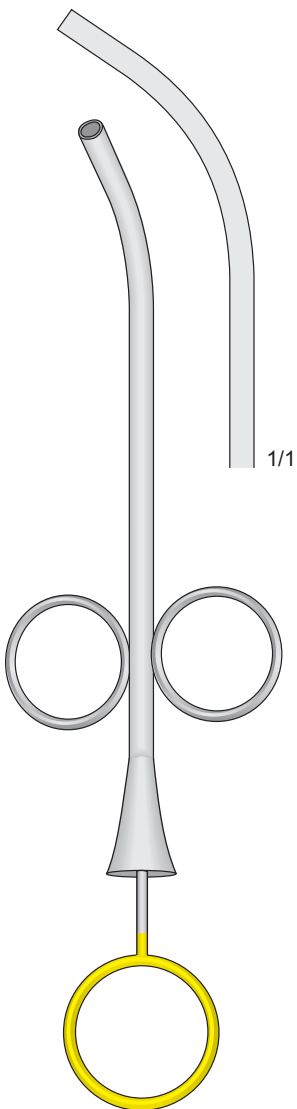

SS-61M
160 mm

Ø Int. 4,4 mm
Ø Est. 5,5 mm

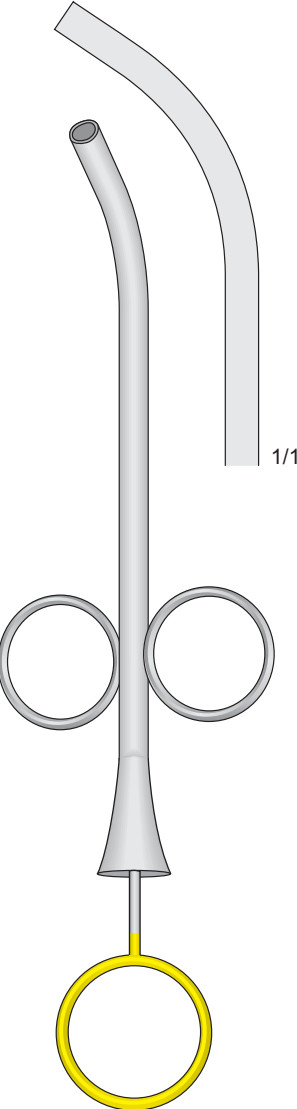

SS-62M
160 mm

Ø Int. 6 mm
Ø Est. 7 mm

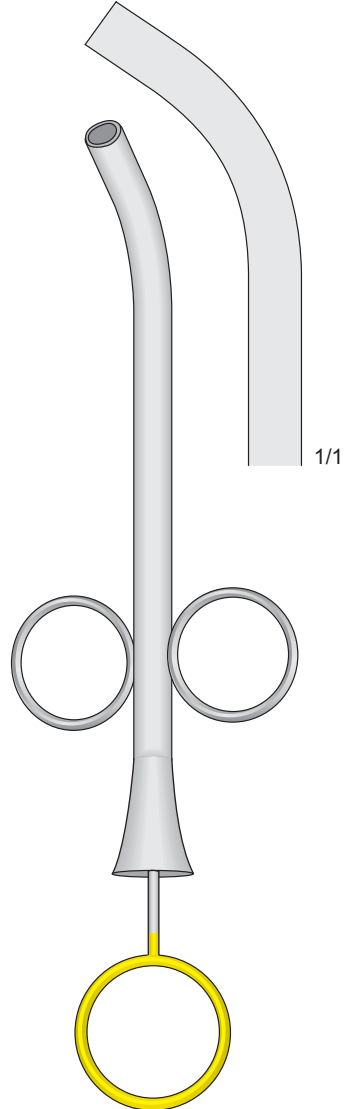

SS-64M
160 mm

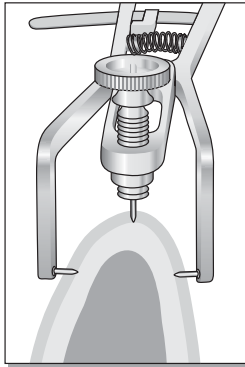

Con punte in titanio

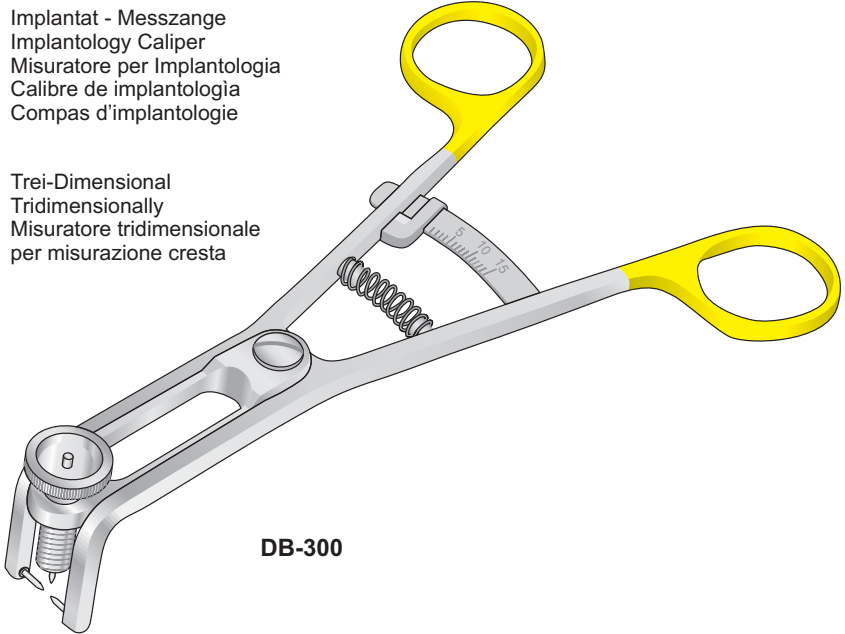

DB-300

Implantat - Messzange
Implantology Caliper
Misuratore per Implantologia
Calibre de implantologia
Compas d'implantologie

Trei-Dimensional
Tridimensionally
Misuratore tridimensionale
per misurazione cresta

Bohrzangen für Knochen-Transplantate
Bone graft holding and drilling forceps
Pinza di fissaggio Graft
Pinzas para coger y taladrar óseo

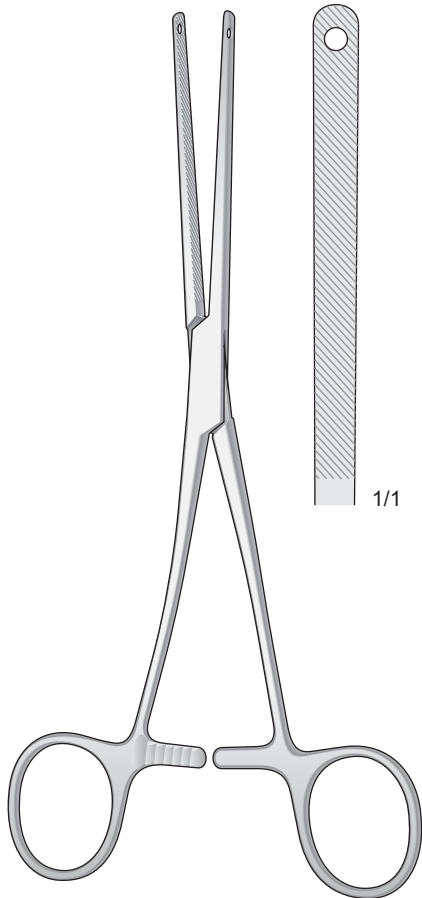

P-340
220 mm

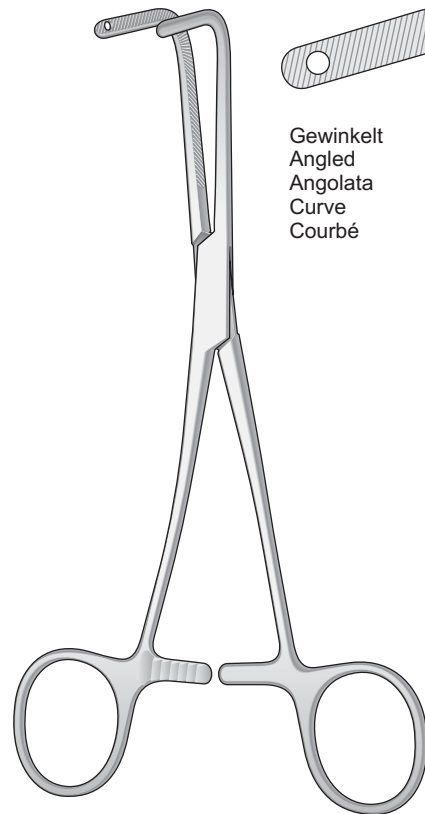

P-341
200 mm

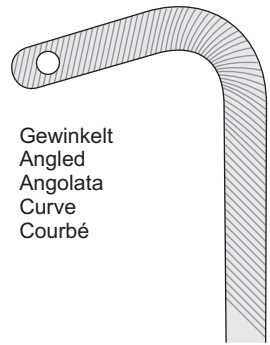

Gewinkelt
Angled
Angolata
Curve
Courbé

1/1

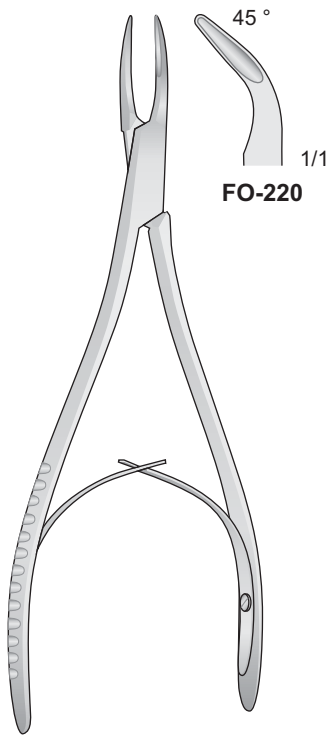

MINI-FRIEDMANN
FO-220
150 mm

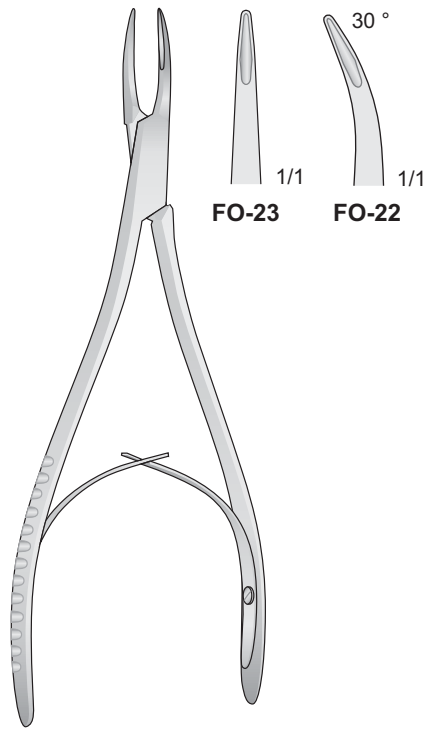

MINI-FRIEDMANN
FO-22/FO-23
150 mm

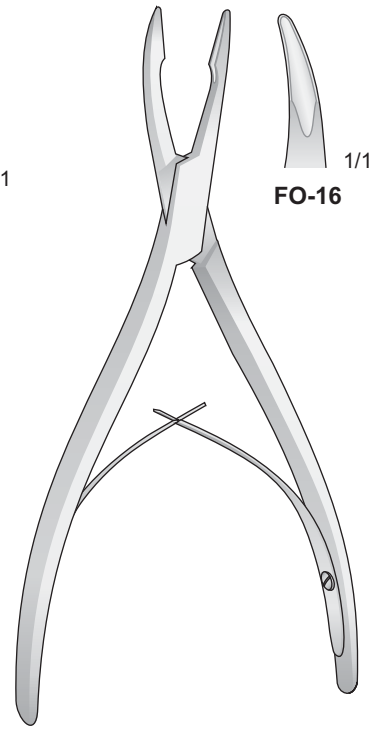

FRIEDMANN
FO-16
160 mm

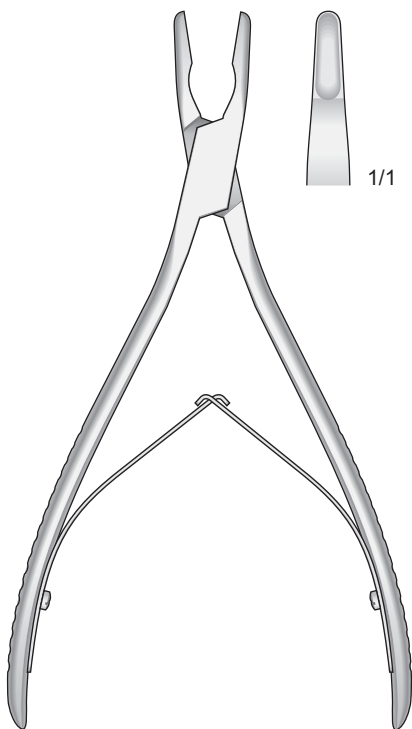

LEMPERT
FO-229
155 mm

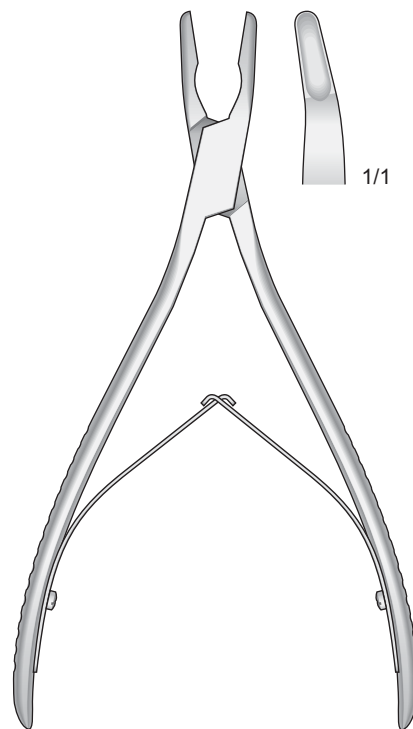

LEMPERT
FO-230
155 mm

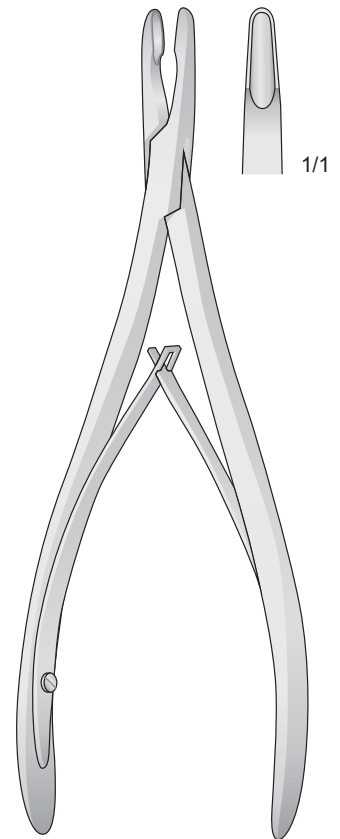

LEMPERT
FO-25
190 mm

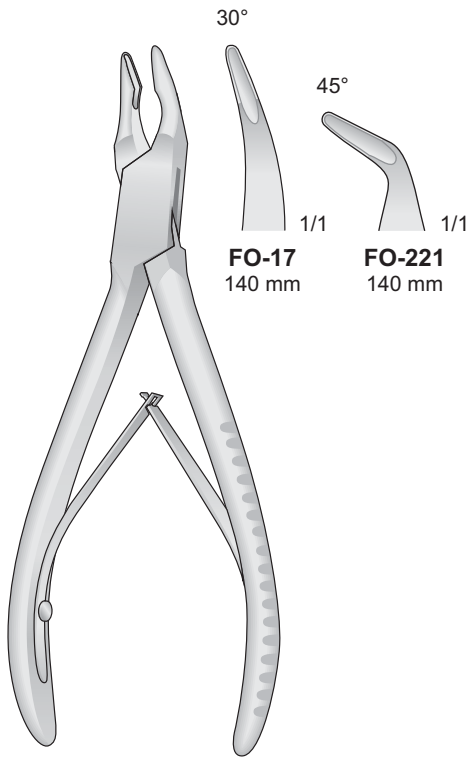

FRIEDMANN
FO-17/FO-221
140 mm

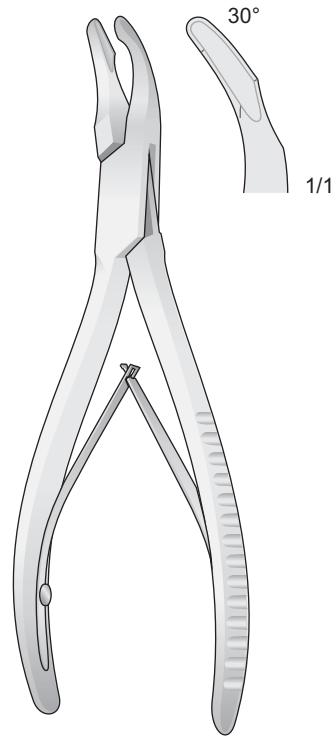

CLEVELAND
FO-231
140 mm

Knochensplitterzange
Bone cutting forcep
Pinza tagliente per ossa
Pinzas cortante para huesos
Pinces coupantes à os

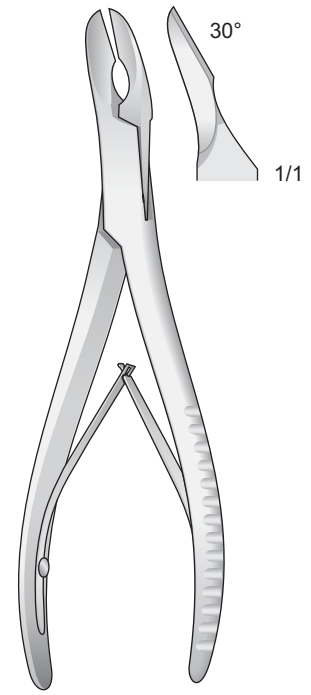

CLEVELAND
FO-233
150 mm

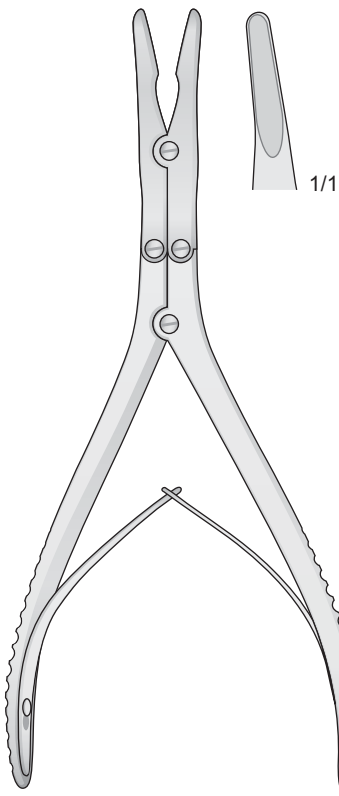

BEYER
FO-20
180 mm

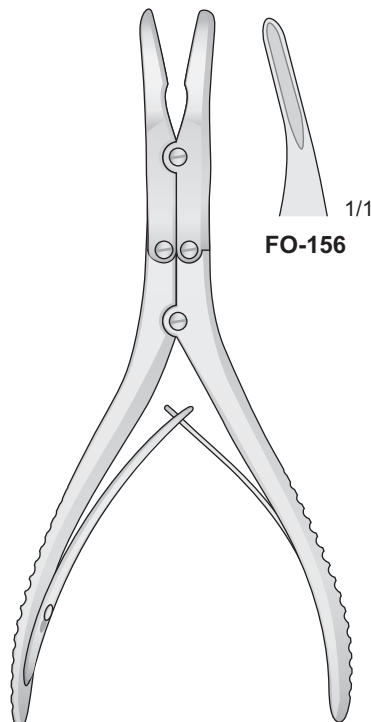

KLEINERT-KUTZ
FO-156
155 mm

Knochenhaltezange
Bone holding forceps
Pinza per fissare l'osso
Pinzas para coger huesos
Pinces pour tenir l'os

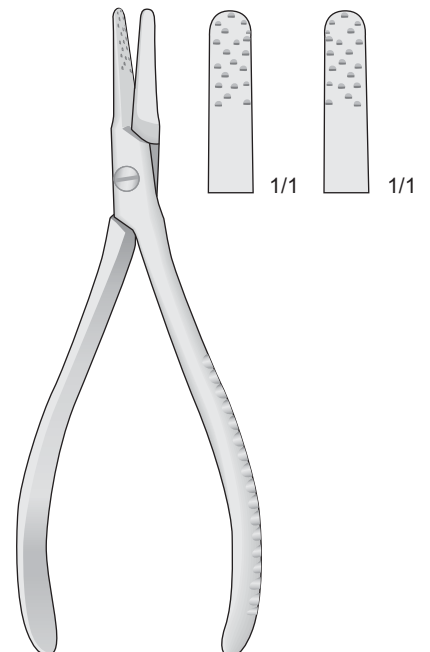

RADOLF
FO-159
135 mm

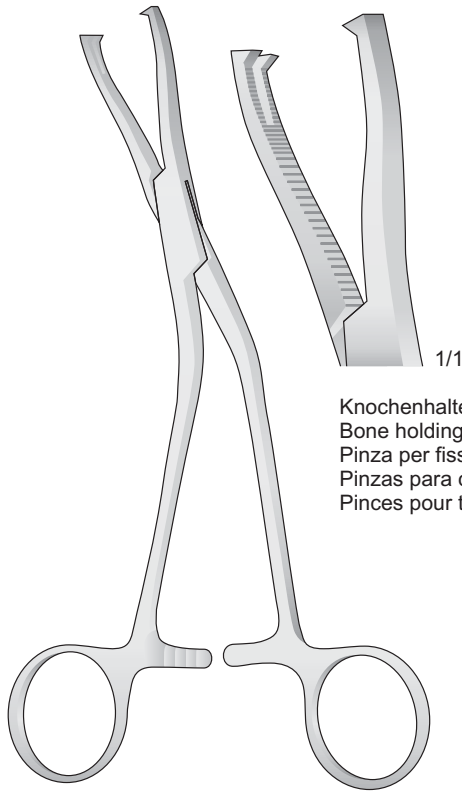

Knochenhaltezange
Bone holding forceps
Pinza per fissare l'osso
Pinzas para coger huesos
Pinces pour tenir l'os

DINGMANN - Mod. Fenestrated Jaw
FO-131
190 mm

Knochenquetsche - Bone Crusher
Pinza per modellare l'osso - Aplastador óseo
Broyeur d'os

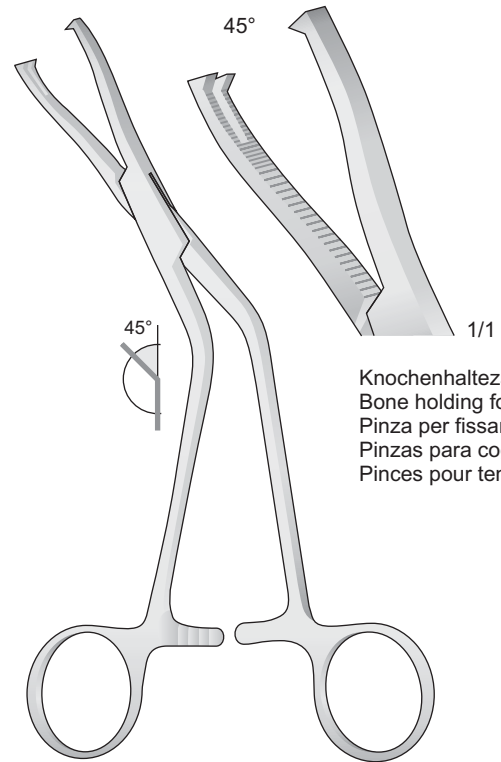

Knochenhaltezange
Bone holding forceps
Pinza per fissare l'osso
Pinzas para coger huesos
Pinces pour tenir l'os

DINGMANN - Mod. Fenestrated Jaw
FO-131M
190 mm

Knochenstanze - Bone rongeur
Pinza per osso - Pinza gubia
Pince gouge

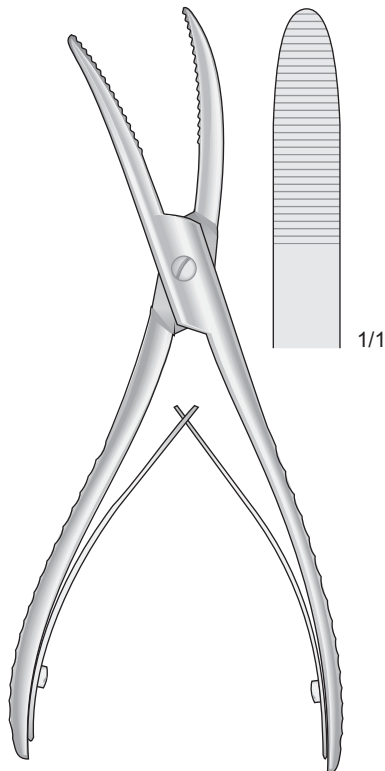

WOLFF
LX-113
180 mm

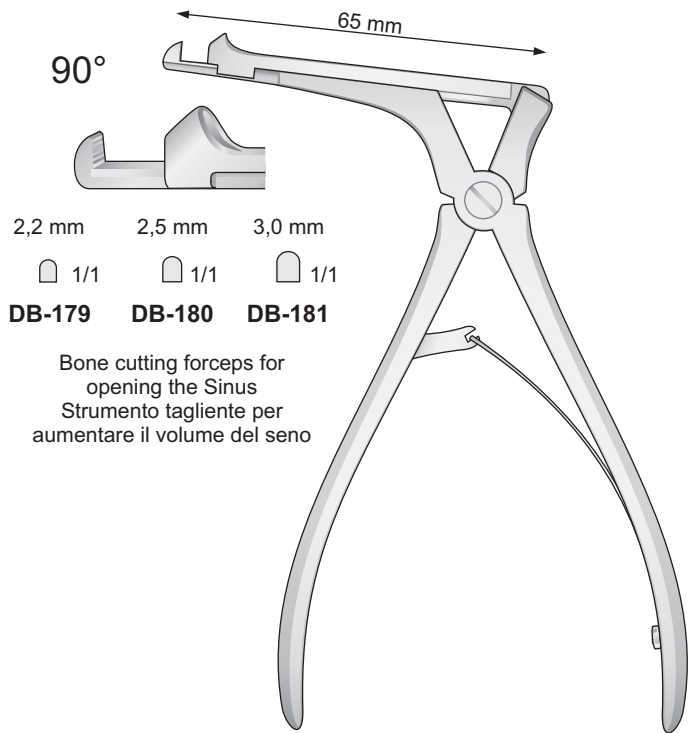

2,2 mm 2,5 mm 3,0 mm
1/1 1/1 1/1
DB-179 DB-180 DB-181

Bone cutting forceps for
opening the Sinus
Strumento tagliente per
aumentare il volume del seno

CITELLI
DB-179/DB-181



Absaugkanülen

Suctions tubes

Cannule per aspirazione

Cànulas aspiradoras

Canules d'aspiration

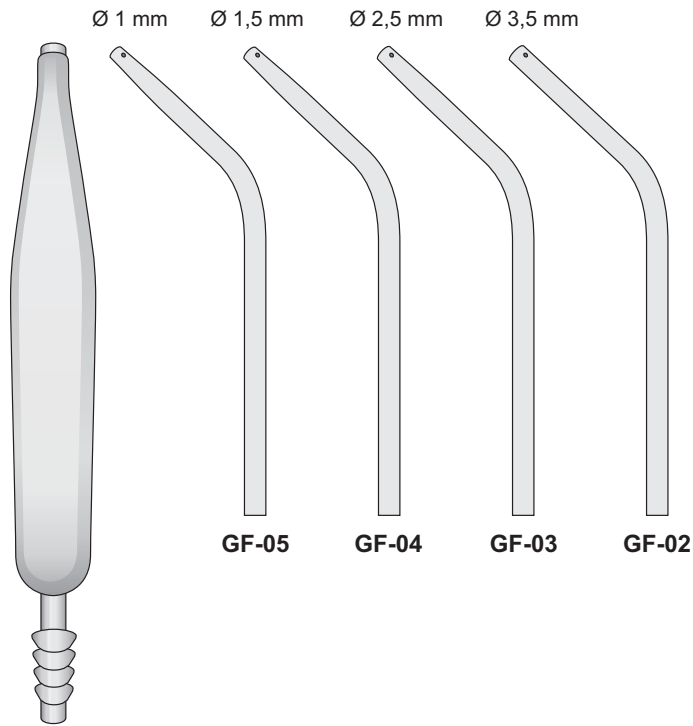

GF-11
 Komplet mit Griffe und 4 Absaugkanülen
 Complete with Handles and 4 Suction tubes
 Completo di manico con 4 cannule
 Completo con Mango y 4 Canulas
 Complete avec Manche e 4 Cànulas

GF-01 GF-02 GF-03 GF-04 GF-05

COUPLAND
GF-01
 150 mm

Rostfrei - Stainless steel
 Acciaio chirurgico - Acero - Acier

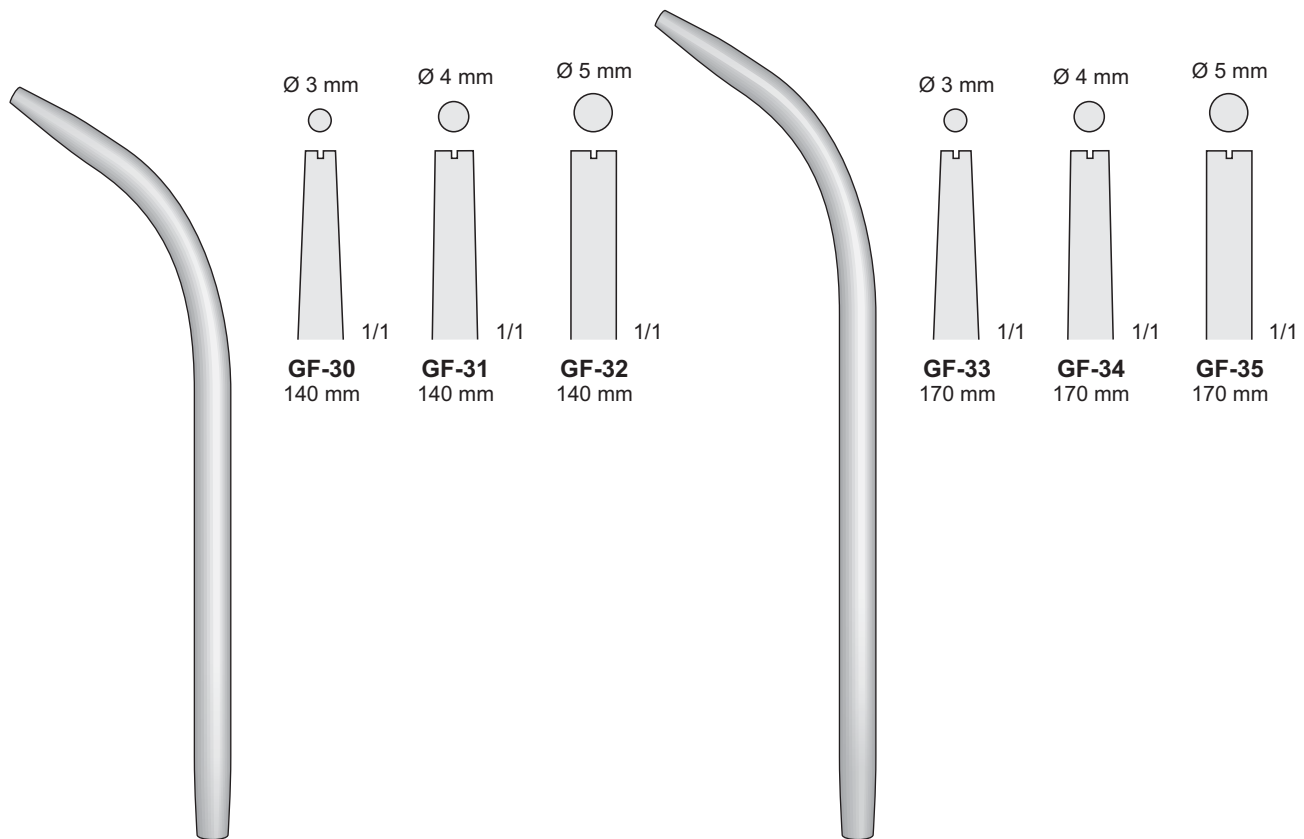

GF-30/GF-32

GF-33/GF-35



Spülkanüle - Irrigation Needle
Aghi da lavaggio per ripulitura seno mascellare
Agujas de instilacion - Aiguilles d'irrigation

Ø 1 mm



1/1

HEPARIN
OL-07 60 mm
OL-25 80 mm

Ø 1,5 mm



1/1

HEPARIN
OL-08 60 mm
OL-26 80 mm

Metallschalen
Stainless Steel Bowls
Capsule inox con fondo piano e becco
Cubetas de acero inox
Cuvettes de acier inox

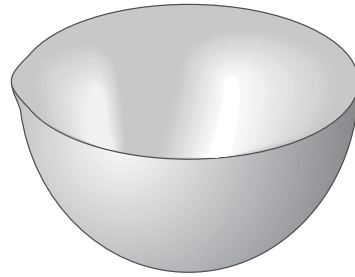

CS-01 Ø 40 mm 15 cc
CS-02 Ø 60 mm 75 cc
CS-03 Ø 80 mm 225 cc
CS-04 Ø 100 mm 325 cc
CS-05 Ø 120 mm 500 cc

Ø Est. 8 mm
Ø Int. 6 mm
1/1

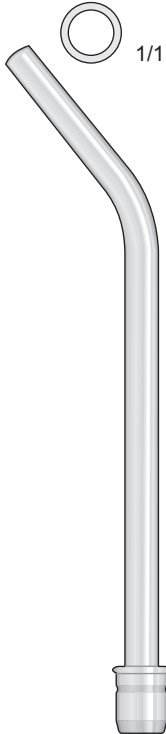

PELTON-CRANE
GF-184
140 mm

Ø Est. 5 mm
Ø Int. 2,5 mm

1/1

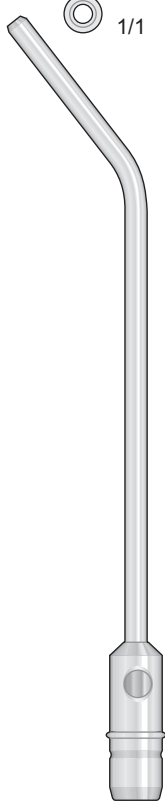

PELTON-CRANE
GF-180
160 mm

1/1

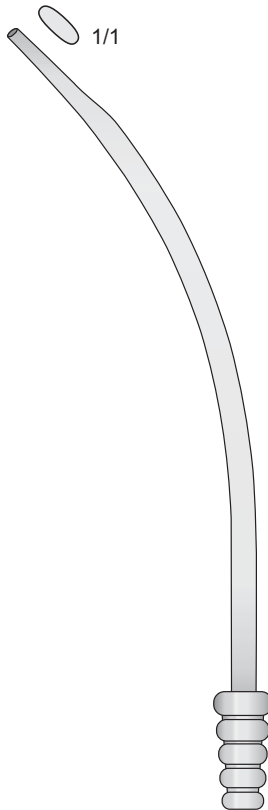

GF-20
160 mm

14 mm

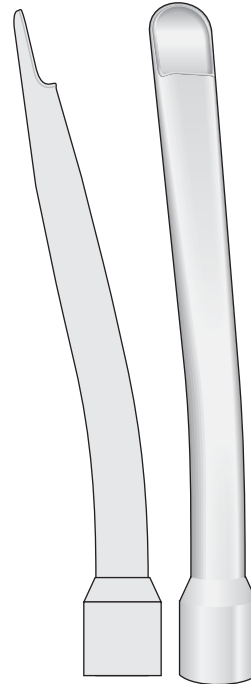

Ø 11 mm

GF-206
130 mm

Ø 4 mm
Ø 5 mm

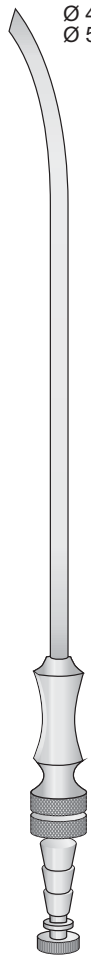

ADSON
GF-41 ch. 12
GF-42 ch. 15
210 mm



Dental Trays
Container

Dental Trays
Containers

Trays
Contenitori per sterilizzare

Trays
Contenedores para esterilización

Trays
Containers pour stériliser

Tray Inox mit Silikoneinrichtung - Stainless Steel Cassettes with Silicone Racks
Tray Inox con griglia in silicone - Recipientes de acero con equipo de silicona
Cassettes en acier avec aménagement en silicone

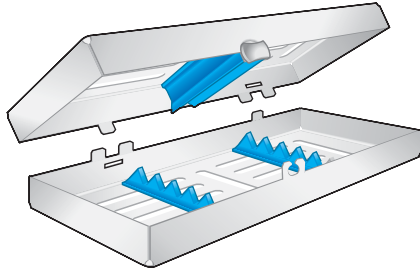

BS-59 Für 5 Instrumente
For 5 Instruments
Per 5 strumenti
Para 5 instrumentos
Pour 5 instruments
185 x 75 x 35 mm

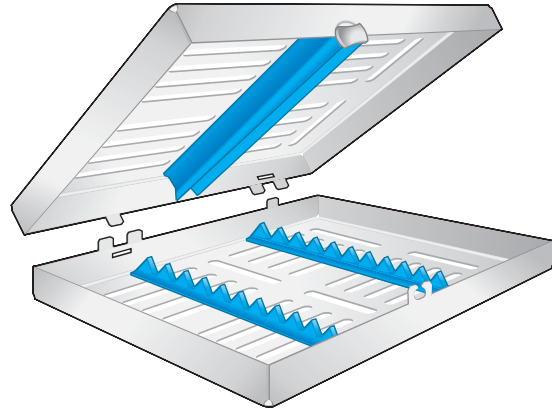

BS-60 Für 10 Instrumente
For 10 Instruments
Per 10 strumenti
Para 10 instrumentos
Pour 10 instruments
185 x 135 x 35 mm

BS-61 Für 20 Instrumente
For 20 Instruments
Per 20 strumenti
Para 20 instrumentos
Pour 20 instruments
290 x 185 x 35 mm

CT-555
CT-560
CT-565



Sterilcontainer,
mit Deckel- und Bodenperforation,
passend in gängige Praxisautoklaven
Containers for sterilization,
with perforation in lid and bottom,
suitable for common practice autoclaves
Contenitori dentali,
con coperchio e fondo perforato,
adatti a tutte le autoclavi comuni
Contenedores dentales,
con tapa perforada y fondo perforado,
aptos para autoclaves habituales
Containers stérile,
avec perforation du couvercle et du fond,
convenant aux autoclaves courants
pour cabinets médicaux

CT-651
CT-652
CT-653



Silikon Noppenmatten - Silicon Mats
Tappeti in aghi di silicone
Tapete en agujas de silicona
Tapis en Silicone

Sterilisierbar - Autoclavable
Autoclavabili - Esterilizable
Stérilisable



CT-555
300 x 140 x 40 mm
CT-651
310 x 190 x 40 mm

CT-560
300 x 140 x 70 mm
CT-652
310 x 190 x 65 mm

CT-565
300 x 140 x 100 mm
CT-653
310 x 190 x 130 mm

Alu
Aluminium
Alluminio

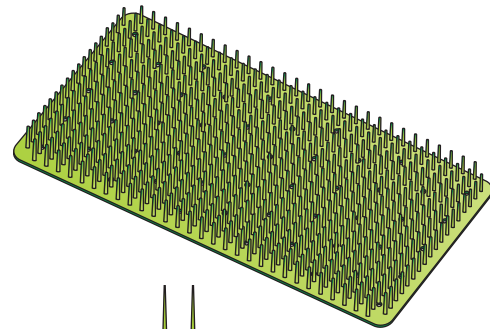

6 mm

TS-103
260 x 120 mm

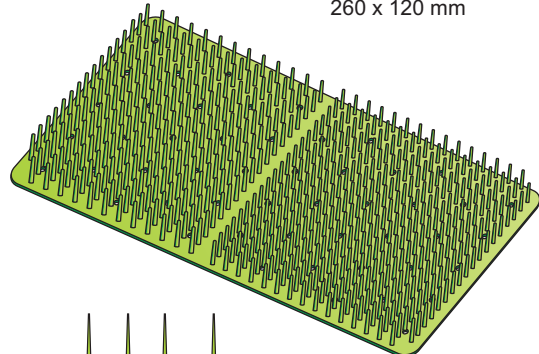

8 mm 10 mm

TS-104
270 x 180 mm

Alfabetisches Inhaltsverzeichnis
Alphabetical Index
Indice alfabetico
Indice alfabetico
Index alphabetique

Nummernverzeichnis
Alphanumerical Index
Indice alfanumerico
Indice alfanumerico
Index alphanumerique



A

ADSON , Absaugkanülen	55
- Pinzetten	8, 11
- Titan-Pinzetten	10
ADSON-BROWN , Pinzetten	8, 11

B

BABBUSH , Raspatorien	27
BABY-CRILE-WOOD , Nadelhalter	15
BEASLEY-BABOCK , Pinzetten	11
BENNETT , Raspatorien	26
BEYER , Hohlmeißelzangen	52
BISHOP , Wangenhalter	21
BISHOP-HARMON , Pinzetten	7
Skalpell	17
BROWN , Pinzetten	8
BRUENINGS , Zungenspatel	21

C

Absaugkanülen	54 - 55
CASTROVIEJO , Pinzetten	8
- Nadelhalter	13, 14
- Meißinstrumente	19
CAWOOD-MINNESOTA , Wangenhalter	21
CITELLI , Hohlmeißelzangen	53
CLEVELAND , Hohlmeißelzangen	52
COLLIN , Zungenzangen	22
Container	56
CORN , Nahtpinzetten	7
COTTLE , Sinus Lift Instrumente	32
COUPLAND , Absaugkanülen	54
COXETER , Scharfe Löffel	30
CRILE-WOOD , Nadelhalter	15
Scharfe Löffel	30 - 33
CUSHING , Wundhaken	24

D

DE BAKEY , Atraumatische Pinzetten	8
- Titan-Pinzetten	10
DEAN , Chirurgische Scheren	6
DESMARRES , Pinzetten	9
DINGMANN , Hohlmeißelzangen	53
Wundhaken	23 - 25

E

EPKER , Osteotome	34
--------------------------	----

F

FARABEUF , Wundhaken	20
Scheren	3 - 6
FREER , Meißel	35
- Raspatorien	28
FREER-YASARGIL , Raspatorien	28
FRIEDMANN , Hohlmeißelzangen	51, 52

G

GABON , Knochenmühle	48
GERALD , Pinzetten	9
- Titan-Pinzetten	10
GIESSEN , Wundhaken	23
GILLIES , Pinzetten	7
GOLDMAN-FOX , Chirurgische Scheren	4
- Raspatorien	26
Knochenschaber	47

H

HALSTED-MOSQUITO , Arterienklemmen	16
HENAHAN , Wundhaken	23
HEPARIN , Spülkanüle	55
HOUSE , Scharfe Löffel	30
HOWARTH , Elevatorien	29
HURD , Elevatorien	29

I

IRIS , Wellenschliff Scheren	5
-------------------------------------	---

J

JACOBSON , Scharfe Löffel	30
- Nadelhalter	14
JACOBSON-MICRO , Arterienklemmen	16
JAMESON-WERBER , Chirurgische Scheren	4
JOSEPH , Elevatorien	29

K

KELLY , Chirurgische Scheren	4
-------------------------------------	---

- Ligaturscheren	6
KEYES , Hautstanzen	45
KILIAN , Raspatorien	27
KLEINERT-KUTZ , Hohlmeißelzangen	52
KOCHER , Arterienklemmen	16
KÖNIG , Raspatorien	27
KÜHNE , Pinzetten	9

L

LA GRANGE , Wellenschliff Scheren	5
LEMPERT , Hohlmeißelzangen	51
LOCKLIN , Chirurgische Scheren	6
LUCAS , Scharfe Löffel	30
LUNIATSCHEK , Membranplatzierungsinstrumente	46

M

MAGILL , Kathetereinführungszangen	22
MALINIAC , Wundhaken	24
Hämmer	36
MATY , Mundsperrer	20
McINTOSH , Laryngoskop	22
MEAD , Hämmer	36
MENEGHINI , Raspatorien	27
METZENBAUM , Chirurgische Scheren	4
- Wellenschliff Scheren	5
MICRO-ADSON , Pinzetten	11
MICRO-VASCULAR , Nadelhalter	15
MILLER-COLBURN , Sinus Lift Instrumente	32
MINI-FRIEDMANN , Hohlmeißelzangen	51
MINNESOTA , Wangenhalter	21
MITCHEL , Dissektor	18
MOLT , Raspatorien	26, 29
- Sinus Lift Instrumente	32

O

OBWEGESER , Wundhaken	24
- Raspatorien	29
OCHSENBEIN , Meißel	35
Osteotome	37 - 44

P

PECK-JOSEPH , Chirurgische Scheren	4
PELTON-CRANE , Absaugkanülen	55
Arterienklemmen	16
Hohlmeißelzangen	51 - 53
Pinzetten	7 - 11
Nadelhalter	13 - 15
PRICHARD , Raspatorien	26

R

RADOLF , Hohlmeißelzangen	52
RAGNELL , Wundhaken	24
RAGNELL-DAVIS , Wundhaken	24
ROGER , Raspatorien	27

S

SAUTHER , Wundhaken	23
Meißel	35
SCHEDE , Scharfe Löffel	33
Raspatorien	26 - 29
SELDIN , Raspatorien	27
SINUS , Sinus Lift Instrumente	32
Küretten	49
SMITH , Chirurgische Scheren	6
SPENCER , Ligaturscheren	6
SPLIT , Scharfe Löffel	34
STEVENS , Delicate Scissors	3
STITCH , Feine scheren	3
Meißinstrumente	19
SWEDESH , Nadelhalter	15

T

TESSIER , Meißel	35
-------------------------	----

V

VOLKMANN , Scharfe Löffel	33
- Küretten	30

W

WALTON , Feine scheren	3
WIEDER , Zungen und Wangenhalter	22
WEITLANER , Tibia Wundspreizer	25
WILLIGER , Elevatorien	29
WOLFF , Hohlmeißelzangen	53
WOODSON , Elevatorien	26

**A**

ADSON, Suctions Tubes	55
- Forceps	8, 11
- Titanium Tissue Forceps	10
ADSON-BROWN, Forceps	8, 11

B

BABBUSH, Periosteal	27
BABY-CRILE-WOOD, Needle holders	15
BEASLEY-BABOCK, Forceps	11
BENNETT, Periosteal	26
BEYER, Bone rongeurs	52
BISHOP, Cheek Retractor	21
BISHOP-HARMON, Forceps	7
Scalpel	17
BROWN, Forceps	8
BRUENINGS, Tongue depressor	21

C

Suctions Tubes	54 - 55
CASTROVIEJO, Forceps	8
- Needle holders	13, 14
- Measuring Instruments	19
CAWOOD-MINNESOTA, Cheek Retractor	21
CITELLI, Bone rongeur	53
CLEVELAND, Bone rongeur	52
COLLIN, Tongue holding forceps	22
Containers	56
CORN, Suture Pliers	7
COTTLE, Sinus Lift Instruments	32
COUPLAND, Suctions Tubes	54
COXETER, Curettes	30
CRILE-WOOD, Needle holders	15
Curettes	30 - 33
CUSHING, Retractors	24

D

DE BAKEY, Non-traumatic Forceps	8
- Titanium Tissue Forceps	10
DEAN, Surgical Scissors	6
DESMARRES, Forceps	9
DINGMANN, Bone rongeur	53
Retractors	23 - 25

E

EPKER, Osteotomes	34
--------------------------	----

F

FARABEUF, Retractors	20
Scissors	3 - 6
FREER, Chisels	35
- Periosteals	28
FREER-YASARGIL, Periosteals	28
FRIEDMANN, Bone rongeur	51, 52

G

GABON, Bone Mill	48
GERALD, Forceps	9
- Titanium Tissue Forceps	10
GIESSEN, Retractors	23
GILLIES, Forceps	7
GOLDMAN-FOX, Surgical Scissors	4
- Periosteals	26
Bone scraper	47

H

HALSTED-MOSQUITO, Hemostatic Forceps	16
HENAHAN, Retractors	23
HEPARIN, Irrigation Needle	55
HOUSE, Curettes	30
HOWARTH, Elevator	29
HURD, Elevator	29

I

IRIS, Wellenschliff Scissors	5
-------------------------------------	---

J

JACOBSON, Curettes	30
- Needle holders	14
JACOBSON-MICRO, Hemostatic Forceps	16
JAMESON-WERBER, Surgical Scissors	4
JOSEPH, Elevator	29

K

KELLY, Surgical Scissors	4
---------------------------------	---

- Suture Scissors	6
KEYES, Tissue Punches	45
KILIAN, Periosteals	27
KLEINERT-KUTZ, Bone rongeurs	52
KOCHER, Hemostatic Forceps	16
KÖNIG, Periosteals	27
KÜHNE, Forceps	9

L

LA GRANGE, Wellenschliff Scissors	5
LEMPERT, Bone rongeur	51
LOCKLIN, Surgical Scissors	6
LUCAS, Curettes	30
LUNIATSCHEK, Membrane placement Instruments	46

M

MAGILL, Catheter introducing forceps	22
MALINIAC, Retractors	24
Hammer	36
MATY, Mouth Gags	20
McINTOSH, Laryngoscope	22
MEAD, Hammer	36
MENEGHINI, Periosteals	27
METZENBAUM, Surgical Scissors	4
- Wellenschliff Scissors	5
MICRO-ADSON, Forceps	11
MICRO-VASCULAR, Needle holders	15
MILLER-COLBURN, Sinus Lift Instruments	32
MINI-FRIEDMANN, Bone rongeurs	51
MINNESOTA, Cheek Retractors	21
MITCHELL, Dissector	18
MOLT, Periosteal	26, 29
- Sinus Lift Instruments	32

O

OBWEGESER, Retractors	24
- Periosteals	29
OCHSENBEIN, Chisels	35
Osteotomes	37 - 44

P

PECK-JOSEPH, Surgical Scissors	4
PELTON-CRANE, Suctions Tubes	55
Hemostatic Forceps	16
Bone rongeurs	51 - 53
Forceps	7 - 11
Needle holders	13 - 15
PRICHARD, Periosteals	26

R

RADOLF, Bone rongeurs	52
RAGNELL, Retractors	24
RAGNELL-DAVIS, Retractors	24
ROGER, Periosteals	27

S

SAUTHER, Retractors	23
Chisels	35
SCHEDE, Curettes	33
Periosteals	26 - 29
SELDIN, Periosteals	27
SINUS, Sinus Lift Instruments	32
Applications Guns	49
SMITH, Surgical Scissors	6
SPENCER, Suture Scissors	6
SPLIT, Curettes	34
STEVENS, Delicate Scissors	3
STITCH, Delicate Scissors	3
Measuring Instruments	19
SWEDESH, Needle holders	15

T

TESSIER, Chicels	35
-------------------------	----

V

VOLKMANN, Bone scoops	33
- Curettes	30

W

WALTON, Delicate Scissors	3
WIEDER, Tongue Depressor	22
WEITLANER, Tibial and iliac Retractor	25
WILLIGER, Elevator	29
WOLFF, Bone rongeurs	53
WOODSON, Elevator	26



A

ADSON , Cannule per aspirazione	55
- Pinzette	8, 11
- Pinzette in titanio	10
ADSON-BROWN , Pinzette	8, 11

B

BABBUSH , Scollaperiosteo	27
BABY-CRILE-WOOD , Port'aghi	15
BEASLEY-BABOCK , Pinzette	11
BENNETT , Scollaperiosteo	26
BEYER , Pinze ossivore	52
BISHOP , Separatore per guancia	21
BISHOP-HARMON , Pinzette	7
Bisturi	17
BROWN , Pinzette	8
BRUENINGS , Abbassalingua	21

C

Cannule per aspirazione	54 - 55
CASTROVIEJO , Pinzette	8
- Port'aghi	13, 14
- Strumenti per misura	19
CAWOOD-MINNESOTA , Separatore per guancia	21
CITELLI , Pinze ossivore	53
CLEVELAND , Pinze ossivore	52
COLLIN , Pinze tira-lingua	22
Contenitori per sterilizzazione	56
CORN , Pinzette per sutura	7
COTTLE , Strumento per rialzo del seno	32
COUPLAND , Cannule per aspirazione	54
COXETER , Curette	30
CRILE-WOOD , Port'aghi	15
Curette	30 - 33
CUSHING , Divaricatori	24

D

DE BAKEY , Pinzette atraumatiche	8
- Pinzette in titanio	10
DEAN , Forbici chirurgiche	6
DESMARRES , Pinzette	9
DINGMANN , Pinze ossivore	53
Divaricatori	23 - 25

E

EPKER , Osteotomi	34
--------------------------	----

F

FARABEUF , Divaricatori	20
Forbici	3 - 6
FREER , Scalpelli	35
- Scollaperiosteo	28
FREER-YASARGIL , Scollaperiosteo	28
FRIEDMANN , Pinze ossivore	51, 52

G

GABON , Macinino per osso	48
GERALD , Pinzette	9
- Pinzette in titanio	10
GIESSEN , Divaricatori	23
GILLIES , Pinzette	7
GOLDMAN-FOX , Forbici chirurgiche	4
- Scollaperiosteo	26
Grattini per osso	47

H

HALSTED-MOSQUITO , Pinze emostatiche	16
HENAHAN , Divaricatori	23
HEPARIN , Aghi da lavaggio	55
HOUSE , Curette	30
HOWARTH , Elevatore	29
HURD , Elevatore	29

I

IRIS , Forbici Wellenschliff	5
-------------------------------------	---

J

JACOBSON , Curette	30
- Port'aghi	14
JACOBSON-MICRO , Pinze emostatiche	16
JAMESON-WERBER , Forbici chirurgiche	4
JOSEPH , Elevatore	29

K

KELLY , Forbici chirurgiche	4
------------------------------------	---

- Forbici per suture	6
KEYES , Punche da Biopsia	45
KILIAN , Scollaperiosteo	27
KLEINERT-KUTZ , Pinze ossivore	52
KOCHER , Pinze emostatiche	16
KÖNIG , Scollaperiosteo	27
KÜHNE , Pinzette	9

L

LA GRANGE , Forbici Wellenschliff	5
LEMPERT , Pinze ossivore	51
LOCKLIN , Forbici chirurgiche	6
LUCAS , Curette	30
LUNIATSCHEK , Strumento per posizionare membrana	46

M

MAGILL , Pinze da intubazione	22
MALINIAC , Divaricatori	24
Martelli	36
MATY , Apribocca	20
McINTOSH , Diagnostica	22
MEAD , Martello	36
MENEGHINI , Scollaperiosteo	27
METZENBAUM , Forbici chirurgiche	4
- Forbici Wellenschliff	5
MICRO-ADSON , Pinzette	11
MICRO-VASCULAR , Port'aghi	15
MILLER-COLBURN , Strumento per rialzo del seno	32
MINI-FRIEDMANN , Pinze ossivore	51
MINNESOTA , Separatore per guancia	21
MITCHELL , Dissettore	18
MOLT , Scollaperiosteo	26, 29
- Strumento per rialzo del seno	32

O

OBWEGESER , Divaricatori	24
- Scollaperiosteo	29
OCHSENBEIN , Scalpelli	35
Osteotomi	37 - 44

P

PECK-JOSEPH , Forbici chirurgiche	4
PELTON-CRANE , Cannule per aspirazione	55
Pinze emostatiche	16
Pinze ossivore	51 - 53
Pinzette	7 - 11
Port'aghi	13 - 15
PRICHARD , Scollaperiosteo	26

R

RADOLF , Pinze ossivore	52
RAGNELL , Divaricatori	24
RAGNELL-DAVIS , Divaricatori	24
ROGER , Scollaperiosteo	27

S

SAUTHER , Divaricatori	23
Scalpelli	35
SCHEDE , Cucchiari per osso	33
Scollaperiosteo	26 - 29
SELDIN , Scollaperiosteo	27
SINUS , Strumento per rialzo del seno	32
Siringhe per osso	49
SMITH , Forbici chirurgiche	6
SPENCER , Forbici per suture	6
SPLIT , Cucchiari per osso	34
STEVENS , Forbici delicate	3
STITCH , Forbici delicate	3
Strumenti per misura	19
SWEDESH , Port'aghi	15

T

TESSIER , Scalpelli	35
----------------------------	----

V

VOLKMANN , Cucchiari per osso	33
- Curette	30

W

WALTON , Forbici delicate	3
WIEDER , Abbassalingua	22
WEITLANER , Divaricatori per tibia e cresta iliaca	25
WILLIGER , Elevatore	29
WOLFF , Pinze ossivore	53
WOODSON , Elevatore	26



Nummernverzeichnis

Alfanumerical Index

Indice alfanumerico

Index alfabétique

Indice alfanumerico

712-163H	33	BT-94	24	FD-587T	12	FL-295	41	GF-31	54	OL-61	45
712-241	26	BT-95	24	FD-588T	12	FL-296	41	GF-32	54	OL-62	45
717-18W	30	BT-96	24			FL-297	41	GF-33	54		
718-24G	26	BT-154	24	FG-1SCZ	5	FL-298	41	GF-34	54	OM-04	21
718-215	28	BT-155	24	FG-2SCZ	5	FL-299	41	GF-35	54	OM-10	22
718-216	28	BT-156	24	FG-92	4	FL-389	39	GF-41	55	OM-12	22
718-EN1	31	BT-183	23	FG-123	4	FL-390	39	GF-42	55	OM-55	21
718-EN2	31	BT-184	23	FG-158	3	FL-391	38	GF-133	46	OM-61	21
718-EN3	31	BT-185	23	FG-159	3	FL-392	38	GF-134	46	OM-66	21
718-GF14	26			FG-160	6	FL-393	38	GF-180	55	OM-74	20
718-M23A	30	BV-23	25	FG-190	4	FL-394	38	GF-184	55	OM-75	20
718-M8	27			FG-191	4	FL-395	38	GF-206	55	OM-76	20
718-M9	26	CS-01	55	FG-209	3	FL-396	39			OM-77	20
718-PR3	26	CS-02	55	FG-210	3	FL-397	39	HB	26	OM-80	21
720-85	30	CS-03	55	FG-211	3	FL-398	39			OM-81	21
720-86	30	CS-04	55	FG-212	3	FL-399	39	IM-15	46	OM-82	21
720-87	30	CS-05	55	FG-216	3	FL-400	38			OM-87	21
720-88	30					FL-400M	39	KO-1	27	OM-88	21
		CT-555	56	FK-1TC	4	FL-404	35	KO-2	27	OM-90	20
AA-S103	22	CT-560	56	FK-2TC	4	FL-411	35	KO-11	27	OM-91	20
AT-12	18	CT-565	56	FK-60	33	FL-412	35	KO-20	27	OM-97	20
		CT-651	56	FK-61	33	FL-413	35	KO-23	27	OM-100	21
		CT-652	56	FK-62	33	FL-414	35	KO-30	29		
BB-46	17	CT-653	56	FK-72	30	FL-415	35	KO-58	26	OP-7	33
BB-48	17			FK-75	30	FL-416	35	KO-66	27	OP-8	33
				FK-80	29						
BD-09T	10	CU-MC1	32	FK-105	25	FM-100	5	LB-15	17	OR-13	19
BD-30T	10			FK-106	25	FM-102	5	LB-361	17	OR-14	19
BD-31T	10	DA-07	7	FK-107	25	FM-126	4	LB-362	17	OR-18	19
BD-51	11			FK-108	25	FM-127	4	LB-363	17	OR-40	19
BD-56	9	DB-52	30	FK-109	25			LB-364	17		
BD-57	9	DB-179	53	FK-120	33	FO-16	51	LB-367	17	OSB-4A	35
BD-58	9	DB-180	53	FK-121	33	FO-17	52				
BD-59	9	DB-181	53	FK-122	33	FO-20	52	LG-1SC	5	P-95	16
BD-71	11	DB-300	50			FO-22	51			P-96	16
BD-73	11			FL-09	36	FO-23	51	LK-2	6	P-97	16
BD-75T	10	DEAN	6	FL-09R	36	FO-25	51			P-98	16
BD-80T	10			FL-11	36	FO-131	53	LS-08	19	P-262	16
BD-82	8	DO-09	22	FL-11R	36	FO-131M	53	LS-09	19	P-263	16
BD-90	11	DO-47	32	FL-12	36	FO-156	52			P-266	16
BD-130	9	DO-59	29	FL-12R	36	FO-159	52	LX-113	53	P-267	16
BD-141	11	DO-63	29	FL-25	44	FO-220	51			P-340	50
BD-158	7	DO-65	29	FL-26	44	FO-221	52	MA-2	18	P-341	50
BD-159	7	DO-67	29	FL-27	44	FO-229	51	MA-7	17		
BD-160	8	DO-180	34	FL-28	44	FO-230	51	MA-B1	17	PF-6	46
BD-160T	10	DO-181	34	FL-31	33	FO-231	52	MA-B3M	17		
BD-161	8	DO-182	34	FL-35	33	FO-233	52				
BD-165	8	DO-183	34	FL-37	44			MC-11	18	PH-53	15
BD-177	11	DO-184	34	FL-38	44	FR-16	28	MC-12	18	PH-54	15
BD-178	11	DO-185	34	FL-39	44	FR-17	28	MC-13	18	PH-65	15
BD-230	8	DO-186	34	FL-65	43	FR-160	30			PH-79	15
BD-231	8	DO-187	34	FL-66	43	FR-162	30	MF-101	9	PH-90	15
BD-250	8	DO-188	34	FL-67	43	FREER	28	MF-101T	10	PH-101	15
BD-251	8	DO-200	24	FL-68	43			MF-102	9	PH-106	15
BD-253	8	DO-204	23	FL-69	43	G-31	18	MF-102T	10		
BD-270	7			FL-70	42	G-32	18	MF-103	9	PR-3A	26
BD-270T	10	EN-M1	31	FL-71	42	G-33	18	MF-104	9		
BD-280	7	EN-M2	31	FL-72	42	GA-33	45	MF-112	12	RH-5	17
BD-284	7	EN-M3	31	FL-73	42	GA-34	45	MF-113	12	SC-14	6
BD-285T	10	EN-M4	31	FL-74	42	GA-35	45	MF-114	12	SC-16	6
BD-348	8	EN-M5	31	FL-75	42	GA-36	45	MF-177	7		
BD-349	8	EN-M6	31	FL-76	42	GA-37	45	MF-342T	10	SL-1	32
BD-351	7	EN-M7	31	FL-77	42	GA-60	19			SL-2	32
BD-352	7			FL-78	43	GA-63	45	MO-8	26		
BD-353	7	ES-13	18	FL-79	43	GA-64	45	MO-9A	26	SM-15	19
BD-354	7	ES-27	26	FL-80	43	GA-65	45	MO-10	32		
BD-355	7	ES-44	9	FL-120	40	GA-66	45	MO-12	32	SS-60M	49
BD-356	7			FL-121	40	GA-80	47	MO-15	29	SS-61M	49
BD-372	11	FD-21	13	FL-122	40	GA-85	47	MO-20	27	SS-62M	49
BD-373	11	FD-22	13	FL-123	40	GA-90	47	MO-24	27	SS-64M	49
		FD-23	13	FL-124	40	GA-95	48			SS-65	46
		FD-25	13	FL-125	40	GA-96	48	MPI-1	46		
BS-59	56	FD-28	13	FL-141	37	GA-97	48				
BS-60	56	FD-29	13	FL-142	37	GA-98	48	NK-2	17	TG-15	35
BS-61	56	FD-30	14	FL-143	37	GA-99	48	NK-11	17	TG-20	35
		FD-31	14	FL-144	37	GA-100	48	NK-17	17	TG-21	35
BT-1	29	FD-32	14	FL-151	45			NK-39	17	TG-22	35
BT-2	29	FD-34	14	FL-152	45	GF-01	54	NK-105	23	TG-23	35
BT-05	23	FD-36	14	FL-153	45	GF-02	54	NK-249	23	TG-30	35
BT-06	23	FD-37	14	FL-156	45	GF-03	54	NK-251	23	TG-31	35
BT-07	23	FD-170	13	FL-157	45	GF-04	54			TG-32	35
BT-07M	23	FD-171	13	FL-158	45	GF-05	54	OL-07	55	TS-103	56
BT-20	20	FD-172	14	FL-292	41	GF-11	54	OL-08	55	TS-104	56
BT-25	20	FD-173	14	FL-293	41	GF-20	55	OL-25	55		
BT-26	24	FD-574T	12	FL-294	41	GF-30	54	OL-26	55		
BT-27	24	FD-575T	12								
BT-29	24										

